

TRC Series Touchscreen Room Controllers

The TRC Touchscreen Room Controllers have been designed for climate control in room spaces with modern sharp slim line 3.5" colour touchscreen interface. The controllers have up to two heating and cooling temperature control stages, fan speed control, optional CO₂ level and humidity control. The units can be in various climate control applications fan coil units, chilled ceiling and zone heating/cooling systems.

The TRC-3A controllers have 3 x analogue 0-10V outputs, two external sensors inputs and one digital input. The TRC-2A3R has three relays for fan. The TRC-1A2T has PWM outputs for heating and cooling. The controller offers PI-control for accurate energy efficiency.

The devices are available with both Modbus RTU and BACnet MS/TP communication.



Features

- 24VAC/DC Power Supply
- 3.5" Backlit Touchscreen Display
- BACnet and Modbus Communication Models
- Flush Mounting in the US, UK or EURO Wall Mounting Box
- Built-In Temperature Sensor, up to 2 x Remote NTC10 Sensors
- TRC-3A: 3 x 0-10V Control Outputs (htg/clg/fan, configurable)
- TRC-2A3R: 2 x 0-10V (htg/clg) and 3 x Fan Relays
- Digital Input for Overrides
- Control of up to three control stages; Comfort, ECO and OFF Control Modes
- CE-Models: Lights, Blinds and Boost Control

Ordering guide

		Type	0	1	2	3	4	5	6
0 Touchscreen room controllers			6001			2			
1 Device type	Room controller, 2Rl, 1DI, 3AO	TRC-3A		C					
	Room controller, 1Rl, 1DI, 2AO, 3RO, 0.5 A	TRC-2A3R		D					
	Room controller, 1Rl, 1DI, 2AO, 3RO, 7A	TRC-H-2A3R		E					
	Room controller, 2Rl, 1DI, 1AO, 2DO	TRC-1A2T		F					
	Room controller, 2Rl, 1DI, 1AO, 3RO, 1RO	TRC-1A4R		G					
	Room controller, 2Rl, 1DI, 3RO (7A), 2DO	TRC-H-3R2T		H					
2 Communication	Modbus	-MOD			M				
	BACnet	-BAC			B				
3 Power supply	24 Vac/dc	-24				2			
4 Additional measurements	No additional measurement							0	
	Relative humidity	-RH						1	
	CO ₂	-CO ₂						2	
	Relative humidity and CO ₂	-RH-CO ₂						3	
5 Advanced options	No advanced options								0
	0..10 Vdc input(s) (replaces RI input(s))	-AI							1
	Control extension	-CE							2
	2 x 0..10 Vdc input and control extension	-AI-CE							3
6 Body colour	Chrome								0
	White (RAL 9010)	-W							W
	Black (RAL 8022)	-B							B

Technical Data

Power Supply	Power:	24VAC/DC -10%/+15%, 80mA
Display	Touchscreen	3.5" Backlit Touchscreen, 320 x 480 pixels, 255K colours
Signal Outputs	Analogue Outputs	TRC-3A: 3 x 0..10V < 5mA TRC-2A3R: 2 x 0..10V < 5mA TRC-1A2T/TRC-1A4R: 1 x 0..10V < 5mA
	Relay Outputs	TRC-2A3R: 3 x 0.5A (res.) at 230VAC TRC-H-2A3R/TRC-H-3R2T: 3 x 7A (res.) / 2.2A (inductive) at 230VAC / 3 x 7A (res.) / 1.3A (inductive) at 115VAC TRC-1A4R: 4 x 0.5A (res.) at 230VAC Note: TRC-2A3RH available on request.
	Digital Outputs	TRC-1A2T/TRC-H-3R2T: 2 x 24VAC 1A Triac (switching to 0V). Note: Requires 24VAC power supply.
Signal Inputs	Built-In Sensor	0..50°C (32..122°F) ±0.5°C (0.9°F) @ 25°C (77°F)
	External Sensor Inputs	TRC-3A/1A2T/1A4R/3R2T: 2 x External NTC10K3 Sensors (RI1 & RI2) TRC-2A3R: 1 x External NTC10K3 Sensor (RI1) Note: Resistive Inputs can also act as Volt-Free Digital Inputs (from Fw2.29 onwards)
	Digital Input	1 x Digital Input, Volt-Free Contact, Impedance <1KOhm
Optional Sensing Characteristics	Carbon Dioxide (CO ₂ Models)	
	Range	0..5000ppm CO ₂
	Accuracy	± 50ppm + 3% of the reading @ 25°C (@77°F)
	Technology	Auto Calibrating; Patented Non-Dispersive Infrared (NDIR)
	Non-Linearity	<1% FS
	Warm-Up Time	<20 seconds
	Response Time	2 minutes
Humidity (RH Models)		
Range	0..100%rH	
Accuracy	±2% rH (within 20..80% rh)	
Communication	Modbus (-MOD models)	
	Protocol	Modbus RTU
	Interface	RS485; maximum 63 devices
	Addressing	1..247 via Touchscreen
	Communication	9k6/19k2/38k4/57k6/76k8 Baud; Parity None/Even/Odd, 1 or 2 Stop Bits (adjustable through Touchscreen)
	BACnet (-BAC models)	
	Protocol	BACnet MS/TP
	Interface	RS485; maximum 63 devices
	MAC Addressing	0.127 via Touchscreen
	Device ID	Default 651000 + MAC Address, Adjustable
Communication	9k6/19k2/38k4/57k6/76k8 Baud; Parity None/Even/Odd, 1 or 2 Stop Bits (adjustable through Touchscreen)	
Connections	Terminal Connections (Power Supply & Analogue Outputs)	Solid and Stranded Cable Maximum Size: Solid: 0.05-2.5mm ² , Stranded: 0.05-1.50mm ² / 14 to 30 AWG (UL) Rising Clamp: Size 2.5 x 2.2mm
	Terminal Connections (Comms and Inputs)	Solid and Stranded Cable; 90° Angle for Wiring Maximum Size: 0.05 to 1.5mm ² (EN ISO) / 14 to 30 AWG (UL) Rising Clamp: Size 2.5 x 1.9mm
Environmental Conditions	Operating	
	Temperature	0°C...+50°C (32..122°F)
	Humidity	0..95%rh (non-cond.)
	Storage	
Temperature	-30°C...+70°C (-22..158°F)	
Humidity	0..95%rh (non-cond.)	

Standards	CE Conformity	CE Directive 2004/108/EC (EMC), 2006/95/EC (LVD) EN61000-6-3: 2001 (Generic Emission) EN61000-6-1: 2001 (Generic Immunity) EN60730-1:2016 (Low Voltage) EN6100-4-2/4/5/11 (ESD, Transient, Surges, Interruptions)
	Degree of Protection	IP20
Housing	Housing Material	Polycarbonate Plastics, Self Extinguishing, Black and Chrome W-Option: White Enclosure - Black Front B- Option: Black Enclosure - Black Front
	Mounting	Wall or Junction Box Mounting
	Dimensions	W88 x H112 x D43mm; Flush: W88 x H112 x D14.5mm
	Weight	220g

TRC-3A Wiring Connections

TRC-3A WIRING

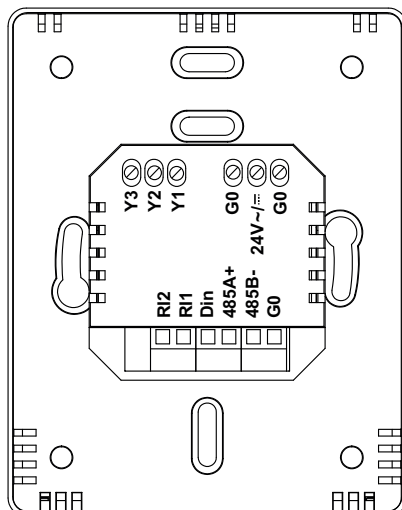

CONN	DESCRIPTION
Y1	0..10Vdc Analogue Output 1 - default fan speed
Y2	0..10Vdc Analogue Output 2 - default heating stage 1
Y3	0..10Vdc Analogue Output 3 - default cooling stage 1
24V	24Vac/dc Supply
G0	0V Common
R11	Remote NTC10 Temperature Sensor Input 1 (0-10V with AI option)
R12	Remote NTC10 Temperature Sensor Input 2 (0-10V with AI option)
Din	Volt-Free Digital Input Contact (dry contact)
485A+	Modbus / BACnet MS/TP RS485 A+ Connection
485B-	Modbus / BACnet MS/TP RS485 B- Connection
G0	0V Common

WARNING: Switch off the power before any wiring is carried out.

TRC-2A3R Wiring Connections

TRC-2A3R WIRING

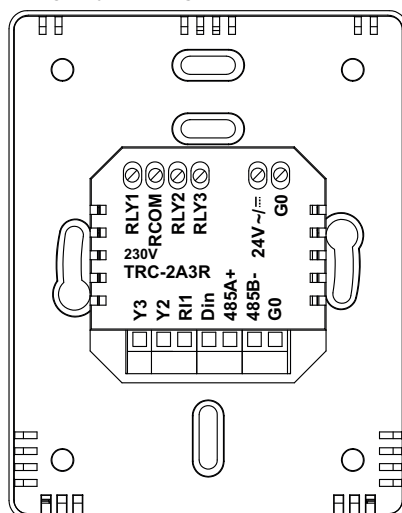

CONN	DESCRIPTION
RLY1	2A3R: 230V 0.5A Relay - Fan Speed 1 H-2A3R: 230V 7A Relay - Fan Speed 1
RLY2	2A3R: 230V 0.5A Relay - Fan Speed 2 H-2A3R: 230V 7A Relay - Fan Speed 2
RLY3	2A3R: 230V 0.5A Relay - Fan Speed 2 H-2A3R: 230V 7A Relay - Fan Speed 2
RCOM	Relay Common
24V	24Vac/dc Supply
G0	0V Common
Y2	0..10Vdc Analogue Output 2 - default heating stage 1
Y3	0..10Vdc Analogue Output 3 - default cooling stage 1
R11	Remote NTC10 Temperature Sensor Input 1
Din	Volt-Free Digital Input Contact (dry contact)
485A+	Modbus / BACnet MS/TP RS485 A+ Connection
485B-	Modbus / BACnet MS/TP RS485 B- Connection
G0	0V Common

WARNING: Switch off the power before any wiring is carried out.

TRC-1A2T Wiring Connections

TRC-1A2T WIRING

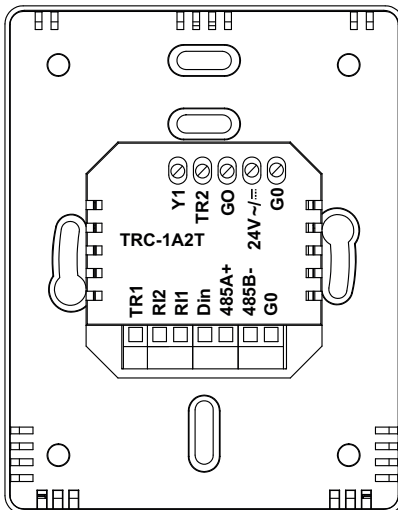

CONN	DESCRIPTION
Y1	0..10Vdc Analogue Output - default fan speed
TR1	24Vac 1A Triac (switched to 0V)- default Heating PWM
TR2	24Vac 1A Triac (switched to 0V) - default Cooling PWM
24V	24Vac/dc Supply
G0	0V Common
R11	Remote NTC10 Temperature Sensor Input 1 (0-10V with AI option)
R12	Remote NTC10 Temperature Sensor Input 2 (0-10V with AI option)
Din	Volt-Free Digital Input Contact (dry contact)
485A+	Modbus / BACnet MS/TP RS485 A+ Connection
485B-	Modbus / BACnet MS/TP RS485 B- Connection
G0	0V Common

TRC-1A4R Wiring Connections

TRC-1A4R WIRING

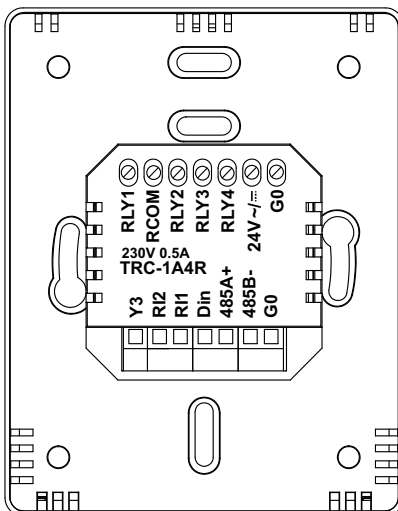

CONN	DESCRIPTION
RLY1	230V 0.5A Relay - Fan Speed 1 / On-Off Valve
RLY2	230V 0.5A Relay - Fan Speed 2
RLY3	230V 0.5A Relay - Fan Speed 3
RCOM	Relay Common
RLY4	230V 0.5A Relay - On-Off Valve
24V	24Vac/dc Supply
G0	0V Common
Y3	0..10Vdc Analogue Output 3 - default cooling stage 1
R12	Remote NTC10 Temperature Sensor Input 2 (0-10V with AI option)
R11	Remote NTC10 Temperature Sensor Input 1 (0-10V with AI option)
Din	Volt-Free Digital Input Contact (dry contact)
485A+	Modbus / BACnet MS/TP RS485 A+ Connection
485B-	Modbus / BACnet MS/TP RS485 B- Connection
G0	0V Common

TRC-H-3R2T Wiring Connections

TRC-H-3R2T WIRING

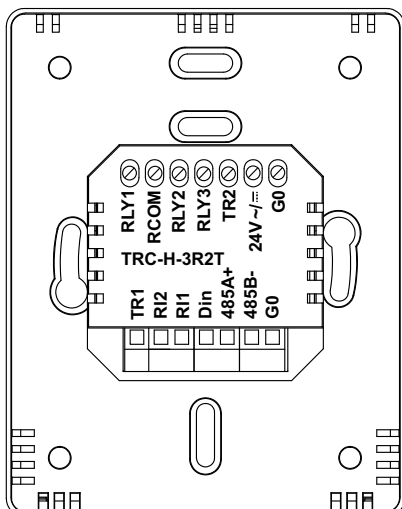

CONN	DESCRIPTION
RLY1	230V 7A Relay - Fan Speed 1 / On-Off Valve
RCOM	Relay Common
RLY2	230V 7A Relay - Fan Speed 2
RLY3	230V 7A Relay - Fan Speed 3
TR2	24Vac 1A Triac (switched to 0V) - default Cooling PWM
24V	24Vac/dc Supply
G0	0V Common
TR1	24Vac 1A Triac (switched to 0V)- default Heating PWM
RI2	Remote NTC10 Temperature Sensor Input 2 (0-10V with AI option)
RI1	Remote NTC10 Temperature Sensor Input 1
Din	Volt-Free Digital Input Contact (dry contact)
485A+	Modbus / BACnet MS/TP RS485 A+ Connection
485B-	Modbus / BACnet MS/TP RS485 B- Connection
G0	0V Common

Application Examples

The below application diagrams show few examples of the TRC Climate Controller applications. The controller is highly versatile and can be easily configured for most room heating and cooling applications including fan coil unit control, chilled ceiling and zone heating control. Please refer to individual set up pages for further details or contact Produal Sales Team for advice.

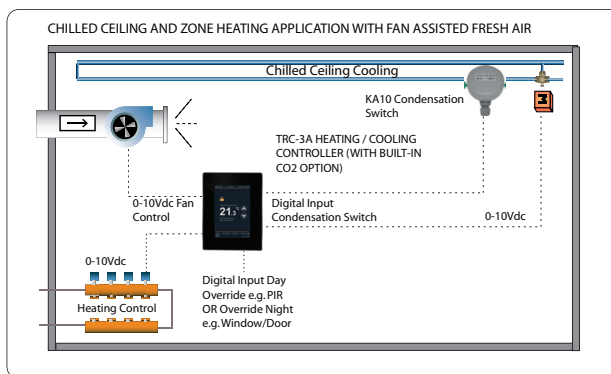
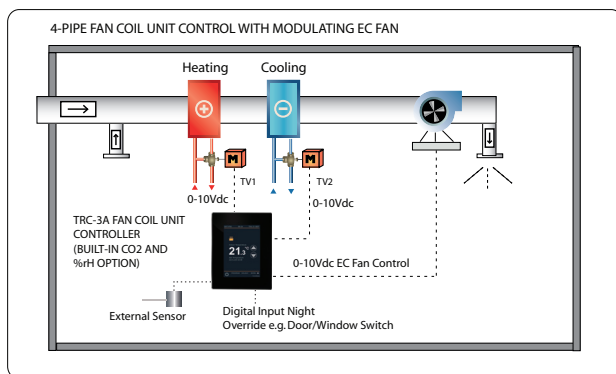

TRC Controller User Interface

The figures below illustrate some of the TRC controller user displays. The multi-colour LCD screen is touch sensitive, easy to adjust and illustrates clearly the plant status information.

ICON DESCRIPTION

- HEATING DEMAND
- COOLING DEMAND
- AT ZERO ENERGY ZONE (NO HTG/CLG)
- COMMS MESSAGE
- CLEANING MODE
- SCREEN LOCKED
- LIGHTS ON/OFF
- BLINDS STATUS
- ERROR
- SCREEN DIM ICON
- MAINTENANCE MODE
- ECO MODE
- FROST PROTECTION ACTIVE
- OFF MODE
- FAN SPEED AND MODE
- LOW/HIGH LIMIT APPLIED

HEATING DEMAND

STATUS INFORMATION BANNER
CENTIGRADE TO FAHRENHEIT SELECTION
INTENSITY OF THE RED ON THE ENERGY RING CHANGES DEPENDING ON DIFFERENCE BETWEEN EFFECTIVE TARGET AND ROOM TEMPERATURES, AT 2°C/3.6°F FULL RED
TARGET SETPOINT ADJUSTMENT BUTTONS
PRESS DIM BUTTON TO SWITCH BACKLIGHT OFF

COOLING DEMAND

LIGHTS STATUS AND CONTROL (CE-OPTION)
BOOST ICON (CE-OPTION)
BLINDS STATUS AND CONTROL (CE-OPTION)
FAN STATUS AND MANUAL CONTROL (FAN ROTATES WHEN RUNNING)
SMALL ACTION CIRCLE

CO2 ALARM DISPLAYS

OK	CO2 AMBER ALARM	CO2 RED ALARM

The colour of the 'Energy Ring' indicates the heating/cooling demand. The 'Energy Ring' is white at 'deadzone'. The density of red/blue on the 'Energy Ring' modulates based on how far from the Effective Heating/Cooling Setpoint the temperature is. When the difference is 2°C/3.6°F the 'Energy Ring' is at full density.

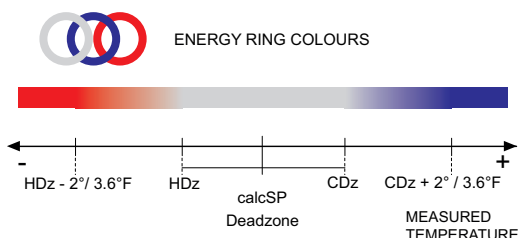

Touchscreen

The TRC controller home screen has a number touch sensitive areas that allow the device settings to be changed.

- UP and DOWN arrows; to alter the current control target setpoint temperature
- SCREEN DIM ICON; dims the screen backlight/ switches backlight off
- SMALL ACTION CIRCLE (that contains current room and/or floor temperature, CO2, humidity etc); allows access to FURTHER SETTINGS AND INFORMATION screen; password protected
- FUNCTION BASED ICON; in OFF mode shows the OFF icon where the OFF mode can be cancelled; in ECO mode shows the ECO icon from where the ECO mode can be cancelled
- FAN SPEED ICON; when FAN display is enabled, the fan ICON can be used to control the fan speed

Additional Features with CE-option.

- BLINDS ICON; when BLINDS are enabled the BLINDS opening can be controlled from this icon
- LIGHTS ICON; when LIGHTS are enabled, the lights can be controlled from this icon
- BOOST ICON; if the BOOST mode is activated, the boost (timed extension) icon is interrogated through the display

Touchscreen Backlight

The touchscreen backlight level can be adjusted through the maintenance mode. During the normal operation after 30 seconds of inactivity, the touchscreen dims to the "stand-by" level set. If the backlight level is set to 0, the screen backlight switches off.

By pressing the DIM icon when the screen is active the screen is immediately dimmed to the "stand-by" level. Pressing the DIM icon when the device is in the "stand-by level", switches the backlight OFF.

The screen backlight is automatically activated when it is touched.

Centigrade to Fahrenheit Display

If Centigrade to Fahrenheit icon has been enabled (parameter System/Show Unit Swap) it is possible on the front screen to change the units by touching this icon.

This option is particularly useful in hospitality applications where the client base is expected to be international.

In addition (from Fw 4.01 onwards) at the commissioning it is possible to select default units from parameter System/Native Units. When changing the Native Units the device carries out Factory Default reload using the selected units (for all relevant settings).

Warning: After changing the Native Units, the controller reloads defaults for ALL PARAMETERS. The Native Unit selection should be done at the start of the commissioning.

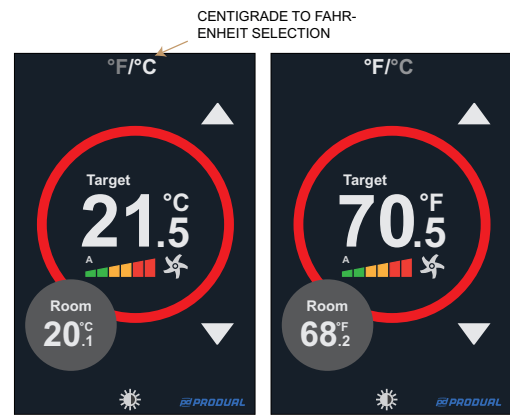

Further Settings and Information

The FURTHER SETTINGS screen shows additional user settings options on the TRC controllers:-

- LOCK icon is used to lock the thermostat. Number of different lock modes options exist.
- ECO icon is used to switch the thermostat to ECO mode (expanded deadzone)
- CLEANING icon is used to enable timed (30 seconds) cleaning mode.
- COG WHEEL icon allows entry to the maintenance mode.

FURTHER SETTINGS screen is protected by STAFF ACCESS code. As default the STAFF CODE is set as '0000' and no password is required to enter the FURTHER SETTINGS screen.

FURTHER SETTINGS AND INFORMATION

ENTRY SCREEN

LARGE CIRCLE CONTINUES TO DISPLAY CURRENT TARGET - TEMP DIFFERENCE

SELECT LOCK ICON TO LOCK THE DEVICE FROM TAMPERING

SELECT CLEANING ICON TO ENABLE CLEANING MODE. THE DISPLAY WILL COUNT DOWN FROM 30 SECONDS DURING WHICH ALL BUTTONS ARE DISABLED ALLOWING SCREEN CLEANING.

USE ESC BUTTON TO SET OR WAIT FOR A TIME-OUT OR SELECT OTHER OPTION

ENTER ECO TIME OR JUST PRESS ENTER FOR ECO MODE

TO ENABLE CLEANING MODE TOUCH THE ICON

SELECT ECO ICON TO ACTIVATE ECO MODE

OFF ICON TO ACTIVATE OFF MODE

SELECT COG WHEEL TO ENTER MAINTENANCE MODE (REQUIRES PASSWORD)

ENTER LOCK CODE TO LOCK THE DEVICE

ENTER LOCK CODE TO LOCK THE DEVICE (DEFAULT 0000)

Temperature Control Loop Operation

The controllers can have up to two heating stages and cooling stages (as default one heating stage and one cooling stage), and can also carry out automatic change-over from heating to cooling via digital input / temperature measurement / network.

This allows various control configurations:-

- One/Two Stage Heating Control
- One/Two Stage Cooling Control
- One/Two Stage Heating and One/Two Stage Cooling Control (up to three outputs)

• One Stage Heating/Cooling Control (Change-Over)

The controller modulates the heating and cooling demand outputs according to the calculated setpoint and the current temperature. The control can be either P-control or PI-control. The calculated setpoint consists sum of Nominal Setpoint (nSP) and the user setpoint adjustment (SPA).

As default for TRC-3A/2A2R, heating stage 1 output is linked to Y2 for modulating 0..10Vdc control, cooling stage 1 is linked to analogue output Y3. With TRC-1A2T/H-3R2T, heating stage 1 is linked to DO1 PWM control and cooling stage 1 is linked to DO2 PWM control.

It is possible to set the control loop outputs to direct/reverse, which reverses the control output (valve) running direction (valve drives from 100% to 0%). This can be configured individually for each stage in the Configuration Parameters.

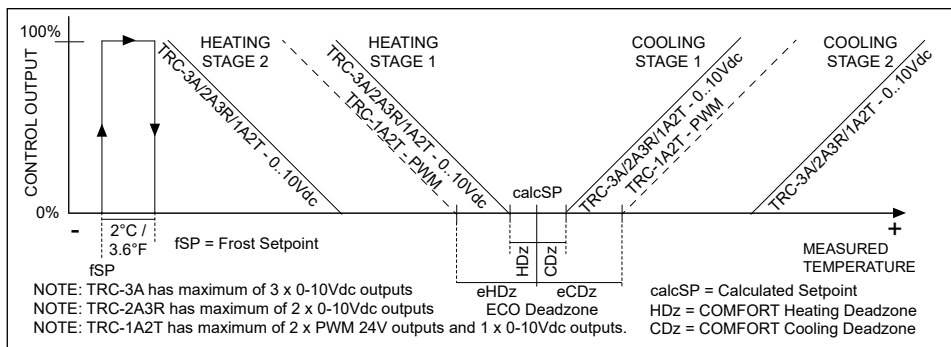

Between heating and cooling stage 1 is a 'deadzone'. With P-control in the 'deadzone' the cooling and heating loop demand is 0%. With PI-control, if the temperature remains in the 'deadzone' for a prolonged period, the heating/cooling demand ramps to 0%. The 'deadzone' allows the temperature to fluctuate around the setpoint without heating or cooling valves starting to open. The TRC has a built-in lock that prevents cooling and heating demands to be on simultaneously.

The 'deadzone' has an individual settings (HDz and CDz) for both heating and cooling side allowing asymmetrical setting. E.g. in some cases it is important that the cooling starts to respond faster than heating when the temperature deviates away from the setpoint.

Note: Conceptually calcSP - HDz is effective Heating Setpoint and calcSP + CDz is Effective Cooling Setpoint. For the user it is easier to set and display a single setpoint and the 'deadzone' limits are set during the commissioning to provide effective heating and cooling setpoints..

The target temperature is typically adjusted by the user by pressing UP & DOWN buttons. The target temperature/deadzone is changed in different operating situations as follows;

- COMFORT MODE; target temperature as adjusted by the user (or via the networked system) and displayed on the screen. The calculated target setpoint (calcSP) consist of the Nominal Setpoint plus the user adjustment (SPA) set via the screen. The user setpoint adjustment is limited by the Setpoint Adjust Max/Min settings (as default +/-3°).
- ECO MODE; target Nominal Setpoint remains the same. The user adjustment (SPA) is disabled and the 'deadzone' settings are expanded to Night Heating Deadzone and Night Cooling Deadzone.
- OFF MODE; the device controls to Frost Setpoint (fSP). The user adjustment (SPA) is disabled.

NOTE: If activated, the High/low Limit Control shifts the effective target temperature (calculated setpoint) as required.

Heating / Cooling Change-Over

The main temperature control loop heating stage 1 and cooling stage 1 can be forced to operate in heating or cooling mode using the change-over function. The change-over is carried out using digital input, temperature measurement or over the network. This allows the same pipe works to be used for both heating and cooling in different seasons.

The change-over function is activated if it is selected for the DI1/RI1/RI2.

With digital input the change-over is activated when the input is activated. Over the network the change-over can be activated by setting the change-over parameter on.

If RI1/RI2 is selected to carry out the change-over, the controller will switch to heating when the temperature exceeds 25°C and to cooling when the temperature drops below 20°C (adjustable).

Note: RI2 is not available with TRC-2A3R.

High/Low Limit Control (Reset Control)

If an external NTC10 sensor is fitted (to RI1 or RI2) and the corresponding high/low limit input has been enabled, the controller can carry out high limit and/or low limit control. In high limit control, if the external temperature exceeds the High Limit setpoint, the main control setpoint is reduced by the amount set in the Limit Ratio per degree. E.g. if the Limit Ratio is 2, every degree that the external temperature exceeds the High Limit setpoint, the target (setpoint) is reset by 2 degrees.

Note: RI2 is not available with TRC-2A3R.

The Low Limit control works in reverse. If the external temperature drops below the Low Limit setpoint, the main control setpoint is increased by the amount of the ratio for every degree below the Low Limit setpoint.

The setpoint reset amount follows the formula:-

$$\text{Setpoint_Reset} = (\text{Limit_Setpoint} - \text{Temperature}) * \text{Limit_Ratio}$$

NOTE: The target setpoint on the display is not changed during the limitation. The limit icon indicates active limitation. To see the effective limited setpoint enter Controller Status and Information display.

Note: The limit function is enabled by setting the Limit Ratio parameter (as default 0.0 = disabled).

Note: In OFF mode high/low limit function is disabled.

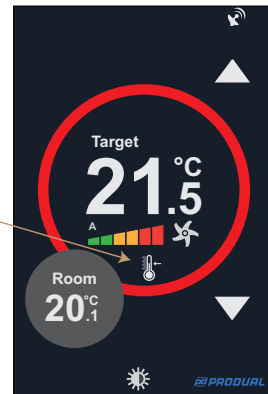

ECO Mode

The device can be switched to ECO mode via network, via digital input (e.g. PIR) or via the touchscreen.

To use the touchscreen enter to the FURTHER INFORMATION screen and select the ECO MODE icon. It is possible to set the number of days of ECO mode. The available range is 0-31 days. After setting the ECO mode, the device immediately switches to the ECO mode.

By setting ECO MODE to 0 or just by pressing ENTER button the device switches to permanent ECO MODE. The ECO MODE can be cancelled by pressing the ECO ICON in the front screen.

In the ECO mode the controller starts to control to ECO Heating/Cooling Deadzone and the user setpoint adjustment (SPA) is removed.

In the ECO mode the CO2 and Humidity loops are switched to 0%.

Depending on the configuration in the ECO mode the lights are switched off to 0%, or continued to be left at the same level as in COMFORT mode. The blinds control remains in the set position.

ECO ICON INDICATES ECO MODE ON, TOUCH TO CANCEL

IF ENABLED BLINDS AND LIGHTS ICON ACTIVE IN ECO MODE

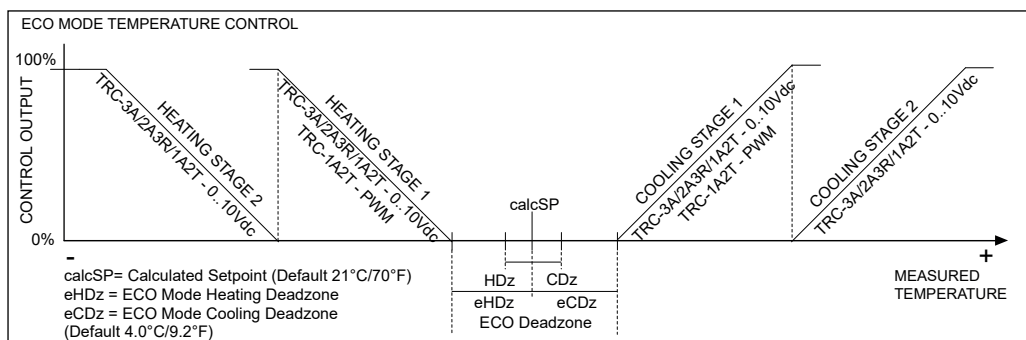
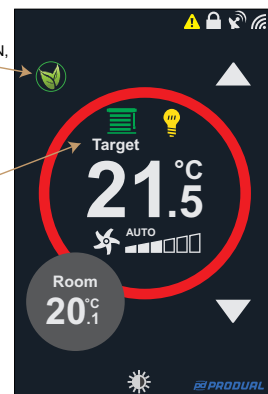

OFF Mode

The controller can be switched to OFF mode via digital volt-free input (e.g. PIR), via FURTHER SETTINGS screen button or via the communication network (system configuration).

In the OFF mode all temperature/CO2/humidity control outputs are switched off to 0% level. The lights are switched off to 0%. The blinds control remains in the set position.

When in OFF mode if the temperature drops below the OFF FROST Setpoint, the frost protection is activated, the SNOWFLAKE icon is displayed on the screen and the heating stages are switched to 100% and the fan speed output is switched to 33%. When the temperature exceeds the OFF FROST setpoint plus 2 degrees, the frost condition is deactivated.

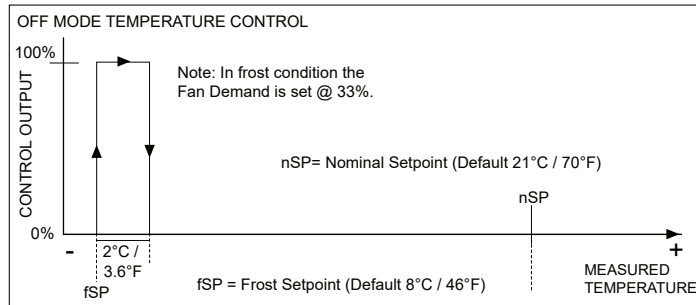
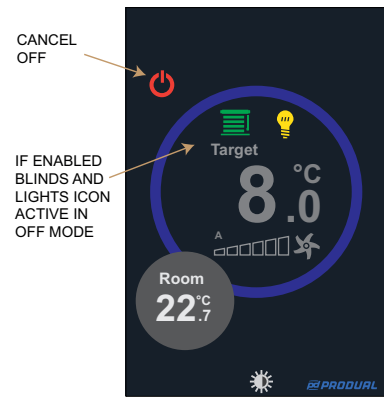

Fan Speed Control

Fan speed control logic adjusts the fan speed based on the demand from 0% to 100%. The fan speed can be configured to follow different control loop outputs using the Fan Speed Source configuration parameter. The options are:-

- HEATING 1 AND COOLING 1 STAGE (Default)
- HEATING STAGE 1
- COOLING STAGE 1
- HEATING AND COOLING STAGE 2
- HEATING STAGE 2
- COOLING STAGE 2
- CO2 LOOP
- HUMIDITY LOOP
- DE-HUMIDITY LOOP
- MAXIMUM VAV; Maximum of Cooling Stage 1 and CO2 Loops
- MAX TEMP/HUM; Maximum of Heating Stage 1, Cooling Stage 1 and Humidity Loops

As default the fan speed control is configured to follow the Heating and Cooling Stage 1. This means that e.g. if Heating Stage 1 output is 55%, and the minimum fan level is set to 0%, the fan speed loop output is also 55%.

Minimum Fan Level parameter is used to set the minimum fan speed during the operation in COMFORT mode. The fan demand is scaled between the Minimum Fan Level and Maximum (100%) - see diagram below for example. The fan speed is 0% in the deadzone area unless Fan Off Delay is set to 0 = Indifinite (default - the fan remains at Minimum Fan Level in deadzone area).

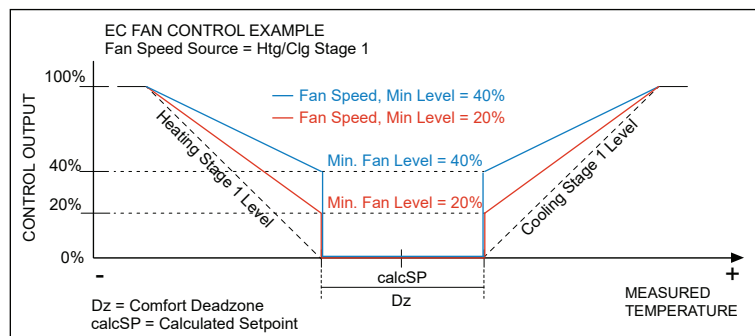

The Fan Off Delay defines time how long the fan overruns in the deadzone (after no demand). E.g. by setting the Fan Off Delay to 30 seconds, the fan switches off after the Htg/Clg Stage 1 demand has remained within the deadzone for 30 seconds (example above).

If maximum speed is required to be set for the fan, this is configured by setting the maximum level in the analogue output (Y1, Y2, Y3) scaling. As default fan speed is configured for Y1.

In ECO mode the Fan Speed control follows the same principle as in the COMFORT mode. In OFF mode the fan is Off unless frost has been detected in which case the fan output is set to 33%.

Automatic Fan Speed Display

Fan speed can be displayed on the screen using coloured bar indicating the speed and rotating fan icon. The display is enabled through the Fan Speed Display parameter. Options are:-

- NONE; no display (Default)
- NO INPUT; no user adjustment
- 0-1; Off/On
- 0-1-2; 2-Speed
- 0-1-2-3; 3-Speed
- 0-1-2-3-4-5-6; 6-Speed

When in Automatic control 'A' is displayed above the coloured bar. The number of bars displayed depends on the fan speed - switching levels described above.

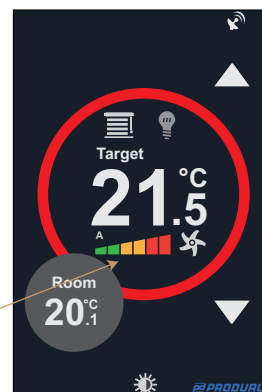

Manual Fan Speed Override

The Fan Speed Display parameter is used to configure Manual Fan Speed Override options; On/Off, 2-Speed, 3-Speed or 6-Speed.

Once activated the user can override the Fan Speed by touching the Fan Icon on the screen. The desired speed can be set by touching multiple times on the screen. When Manual override is active 'M' is displayed above the coloured speed bar.

In ECO mode Manual Override is active. In OFF mode manual override is disabled.

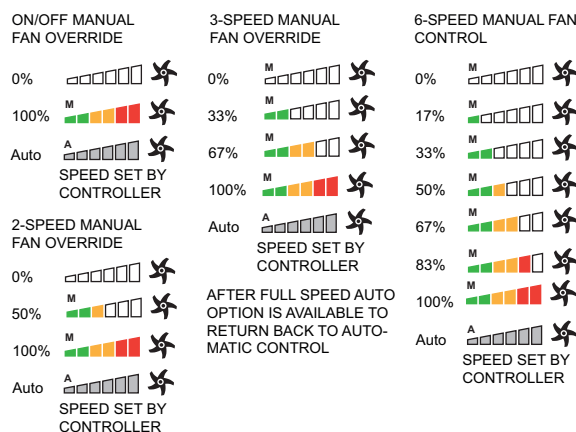

NOTE: Manual Fan Override sets the Fan Speed to defined values as described above and the Min. Fan Level parameter is ignored.

Auxiliary Heating Control Loop

The TRC series controllers have an auxiliary heating temperature control loop. The auxiliary control loop provides additional PI-control function for applications where second control loop is required e.g. second zone temperature control for bathrooms. The auxiliary control loop is activated by selecting Aux control for RI1 or RI2 input. (Aux. Loop is available from Fw 4.01 onwards).

Note: RI2 is not available with TRC-2A3R.

CO2 Sensor Control Loop Operation (TRC-x-CO2 Models)

The CO2 models can measure and control the CO2 level. This can then be used in demand based control applications. The CO2 control output can then be configured to linked to any of the physical control outputs Y1, Y2 or Y3, or used in maximum demand control (MAX VAV, MAX FAN options)

The CO2 control loop output corresponds to the CO2 setpoint and the CO2 proportional band. If configured as Direct Control (typical), then if the CO2 level increases above the setpoint the loop output starts to modulate to 100%. When the CO2 level is the amount of the Proportional Band above the setpoint, the loop output is 100%. The configuration is done via the configuration parameters. The CO2 control loop can also be configured to operate as Proportional + Integral control by changing the Integral Action Time from 0 to a required value. The actuator direction can be changed via Output Direction parameter (Direct, Reverse).

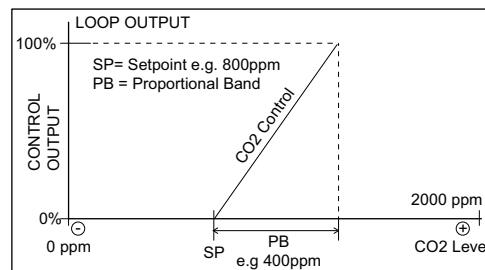

In the OFF mode the CO2 loop output is set to 0%. In the ECO mode the CO2 loop operates as in the day mode.

CO2 sensor display can be enabled / disabled from the configuration parameters (from Fw 4.15).

VAV Maximum Demand

Each of the analogue outputs can also be configured as "Maximum VAV Demand". In this case the corresponding output (Y1, Y2, Y3) takes the maximum of the CO2 Loop and Cooling Temperature Loop demand output. This is typically used in demand based ventilation (VAV) to control fresh air damper when there is either demand for more fresh air, or demand for temperature cooling (typically fresh air cools down the room space).

Maximum Fan Demand

Each of the analogue outputs can be configured as "Maximum Fan Demand". In this configuration the corresponding output (Y1, Y2, Y3) takes the maximum demand of the CO2 Control Loop and Fan Speed Control Loop. This can provide fan speed boost at high CO2 level and when the fan speed temperature loop has increased the demand.

Humidity Control Loop Operation (-RH option)

The RH models can measure and control the relative humidity level. This can then be used in demand based control applications to increase the fresh air supply e.g. in the high humidity conditions. The control loop has both de-humidification and humidification outputs that can be linked to any of the physical control outputs Y1, Y2, or Y3. The direction of the both outputs can also be reversed to driver the actuators 100-0% instead of 0-100%.

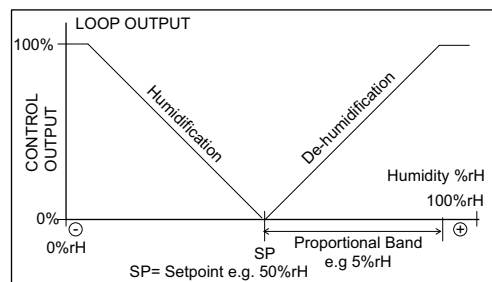

Humidity sensor display can be enabled / disabled from the configuration parameters.

Cleaning Mode

After entering FURTHER INFORMATION screen, by selecting the CLEANING icon, it is possible to activate the cleaning mode. The TRC will enter a "Clean Screen" state where all touchscreen presses are ignored and 30 second countdown timer is displayed. This allows cleaning of the device itself.

Boost Button (requires CE Option)

The device has a boost button that can be linked to override control function for the give boost time. The touchscreen shows the current remaining boost time, and the boost can be cancelled by pressing the (active) Boost icon, or over the network.

The boost target options are:

- BOOST DISABLED
- HEATING STAGE 1
- HEATING STAGE 1&2
- COOLING STAGE 1
- COOLING STAGE 1&2
- HUMIDITY LOOP
- DE-HUMIDITY LOOP
- CO2 LOOP
- FAN

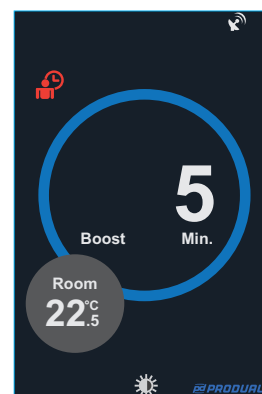

The boost time is adjustable between 0-480 minutes. By setting the time to 0, the BOOST is permanent until either cancelled through the screen or over the network.

NOTE: If Digital Input has been configured to operate as Boost, it cannot be cancelled through the screen, and the boost is active until the state of the input changes (no timer). The digital input boost is indicated by the icon and the 'Target' text is changed to show 'Boost'.

Lights Control (requires CE Option)

The Lights control can be activated by enabling Lights in the Configuration Settings. The lights output level is set automatically to 100% (fully on) when the controller goes to COMFORT mode. The lights output level can be linked to any of the analogue outputs and/or is available as a network variable.

When the controller switches from COMFORT mode to OFF (and configurable ECO) mode, the Lights output is automatically switched to 0% (Lights Off). There is 30 seconds (adjustable) switch off delay on transition.

The Lights Icon is displayed in the HOME SCREEN (if enabled). By pressing the Lights icon it is possible to alter manually the light level (in steps) in COMFORT, ECO and OFF modes. The lights control can have 2 (0-1), three (0-1-2) or four steps (0-1-2-3).



When the Lights icon is pressed the device goes to COUNTDOWN mode for the time set in the Lights Delay Time parameter. In this mode the Lights icon changes colour to brown. If the Lights icon is re-pressed in this mode the countdown is cancelled and the lights are switched back to fully ON level.

The Lights Modes are changed through the configuration settings. The following options are available.

Lights Mode	Description (Typical Operation)
Disabled	Lights icon not visible to the user.
0 - 1	Lights Icon visible to the user in all modes. On/Off Lights Control (2-Steps)
0 - 1 - 2	Lights Icon visible to the user in all modes. 3 Levels Lights Control (0%, 50%, 100%)
0 - 1 - 2 - 3	Lights Icon visible to the user in all modes. 4 Levels Lights Control (0%, 33%, 66%, 100%)

The Lights Interlock parameter is used to define in which modes the Lights are ON.

Lights Interlock	Description (Typical Operation)
Disabled	Operating mode has no impact on the light control.
COMFORT	Lights Output 100% on transition to Comfort Mode. Lights Output 0% (OFF) on transition to ECO/OFF. Modes. Manual and Network Overrides active.
COMFORT + ECO	Lights Output 100% on transition to Comfort Mode. Lights remain at the same level on transition to ECO. Lights Output 0% (OFF) on transition to OFF. Modes. Manual and Network Overrides active.





Blinds Control (requires CE Option)

The Blinds control can be activated by enabling Blinds in the Configuration Settings. The blinds output level can be linked to any of the analogue outputs and/or is available as a network variable

The Blinds Icon is displayed in the HOME SCREEN (if enabled). By pressing the Blinds icon it is possible to manually to set blinds level (in steps) in COMFORT, ECO and OFF modes. The blinds control can have 2 (on/off), or four steps (0%, 25%, 50%, 75%, 100%).

The Blinds Icon and Operating Modes are changed through the configuration settings. The following options are available.

BLINDS STATUS AND CONTROL

-  BLINDS CLOSED
-  BLINDS AT 75%
-  BLINDS AT 50%
-  BLINDS AT 25%
-  BLINDS OPEN

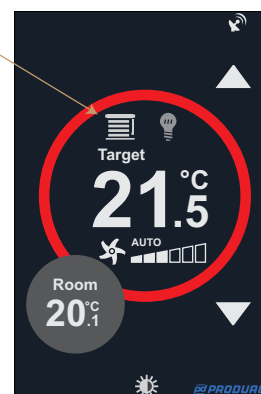

Blinds Mode and Operating Mode Setting	Description (Typical Operation)
Disabled	Blinds Icon not visible to the user.
Enabled, On/Off	Blinds Icon visible to the user in all modes. Two Levels; On/Off. Manual and Network Overrides active.
Enabled, 4 Steps	Blinds Icon visible to the user in all modes. Four Steps; 0%, 25%, 50%, 75%, 100%. Manual and Network Overrides active.

Lock Mode

After entering FURTHER INFORMATION screen, by selecting the LOCK icon it is possible to lock the device. Now by entering the LOCK CODE, the device lock state can be activated.

The lock mode can be configured to work in different ways as described at the below table.

- DISABLED: Lock Mode Icon Not Available
- ON/OFF ONLY: Allows OFF, Lights and Blinds Buttons Only
- ADJUST ONLY: Allows Temperature Adjustment Only
- NO INPUT: All Buttons Locked

If the lock code is set to 0000 (default), there is no need to enter the lock code and the lock entry screen is bypassed.

Note: If the power is switched off and on, the current lock mode status remains active (from Fw 4.15 onwards)

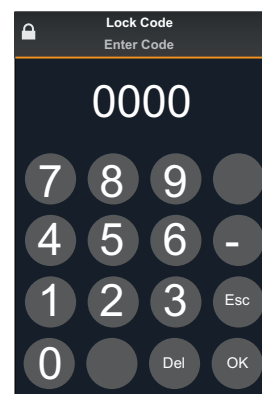

Lock Mode Options	Icon Active / Visible				
	Lock	Up and Down	OFF	Fan / ECO / Cleaning	Blinds / Lights / Boost
DISABLED	NO	YES	YES	YES	YES
ON/OFF ONLY	YES	NO	YES	NO	YES
ADJUST ONLY	YES	YES	NO	NO	NO
NO INPUT	YES	NO	NO	NO	NO

Remote Sensor RI1 and RI2 Inputs (operate also as digital inputs)

A remote NTC10k3 sensor can be connected to the RI1 and RI2 inputs to be used for different control and display purposes. The options are:-

- DISABLED; the measurement is disabled
- ROOM; the input is used for the main temperature control loop
- FLOOR; the input is used for High/Low Limit Control
- OUTSIDE; the input is used to show the Outside Temperature
- HEATING/COOLING; the input is used to switch between heating/cooling modes (changeover)
- NETWORK NTC10; the resistive input is available over the communication network as temperature.
- NETWORK 0-10V; the input is used as 0..10V network monitoring input (requires AI option)
- CO2; the input is used as CO2 0..10Vdc measurement for CO2 control (requires AI option)
- MAIN LOOP; the 0..10Vdc voltage is used for the main temperature control (requires AI option)
- CLOSE FOR ECO; the input operates as volt-free input to override to ECO mode when closed
- OPEN FOR ECO; the input operates as volt-free input to override to ECO mode when open
- CLOSE FOR OFF; the input operates as volt-free input to override to OFF mode when closed
- OPEN FOR OFF; the input operates as volt-free input to override to OFF mode when open
- CONDENSATION; the input is used with resistive condensation sensors to disable cooling when condensation is detected
- NETWORK DI; allows the input to be used as Digital Input for BMS

ROOM allows remote temperature sensor to be used for the main temperature loop control. The internal temperature sensor is disengaged from control.

FLOOR option links the temperature measurement to the High/Low Limit control. When the Floor Control is selected for RI1/RI2, the touchscreen SMALL ACTION CIRCLE starts to display the Floor Temperature (configurable). Note if both RI1/RI2 set to Floor Control RI1 takes precedence.

OUTSIDE allows outside (or network) temperature to be displayed on the screen. When the Outside is selected for RI1/RI2, the touchscreen SMALL ACTION CIRCLE starts to display the Outside Temperature (configurable). Note if both RI1/RI2 set to Outside RI1 takes precedence

HEATING/COOLING option monitors the temperature. If the temperature drops below 20°C cooling mode is activated. If the temperature exceeds 25°C the heating mode is activated (limits adjustable).

NETWORK NTC10 option makes the NCT10 measurement available as temperature over the network.

CONDENSATION option allows the resistive input to be wired to condensation sensor such as KEK1. When condensation is detected the controller disables the Cooling Stages. **Note:** If this mode is required, do NOT set Digital Input Mode to "Cooling Disable" as Digital Input operation takes precedence.

Digital Input Modes

"CLOSE FOR" Configuration - The resistive input can be used as digital volt-free contact can be linked to e.g. external timer to switch the device to OFF mode during the timed period. When the device sees

transition from open (COMFORT) to close (ECO/OFF MODE), the operating mode does not change until the Delay Timer has expired.

"OPEN FOR" Configuration - The resistive input can be used as digital volt-free input to activate ECO or OFF mode when the contact opens. In this mode it can be connected to a window switch, door card switch or PIR sensor. When the device sees transition from closed to open, the operating mode does not change until the countdown timer has expired (DIGITAL INPUT DELAY setting).

NETWORK DI option allows the resistive input to be used as a digital volt-free monitoring point over the Modbus or BACnet network.

Note: Resistive Inputs as a Digital Input operate with approx. ten seconds delay and are not instantaneous. Therefore they are not suitable for fast switching (transition will be missed during the inherent delay time).

Note: RI2 is not available with TRC-2A3R.

2 x 0..10Vdc Input (AI Options)

If the TRC unit has been ordered with AI option, then inputs RI1 and RI2 become 0..10Vdc inputs.

NETWORK 0-10V; this selection allows the 0..10Vdc measurement to be converted to 0..100% and the measurement can be monitored over the network.

CO2; this selection converts the 0..10Vdc input to 0..2,000ppm. The measurement is available over the network for monitoring, and the measurement is automatically linked to the CO2 control.

MAIN LOOP; this selection converts the 0..10Vdc input to 0..50°C. The measurement is available over the network for monitoring, and the measurement is automatically linked to the main temperature control loop.

Note: RI2(AI2) is not available with TRC-2A3R.

DI Digital Input

The digital volt-free contact can be configured to the following options are:-

- CLOSE FOR ECO; Default
- OPEN FOR ECO
- CLOSE FOR OFF
- OPEN FOR OFF
- CHANGEOVER; changes stage 1 control between heating and cooling
- DISABLE COOLING; disabling the cooling stages when ON (condensation)
- CONTACT ALARM
- NETWORK
- CLOSE FOR BOOST (with CE-option only)
- OPEN FOR BOOST (with CE-option only)

"OPEN FOR" Configuration - The digital volt-free input can be used to activate ECO or OFF mode when the contact opens. In this mode it can be connected to a window switch, door card switch or PIR sensor. When the device sees transition from closed to open, the operating mode does not change until the countdown timer has expired (DIGITAL INPUT DELAY setting).

"CLOSE FOR" Configuration - The digital volt-free contact can be linked to e.g. external timer to switch the device to OFF mode during the timed period. When the device sees transition from open (COMFORT) to close (ECO/OFF MODE), the operating mode does not change until the Delay Timer has expired.

CHANGE-OVER - The digital input can also be used to override from heating to cooling mode. The device works in the heating mode when the contact is open, and in the cooling mode when the contact is closed.

DISABLE COOLING - when the digital input is closed the cooling loops are set to 0% to prevent condensation happening. In this mode digital input is typically connected to a condensation sensor such as KA10. **Note. This input takes precedence of the Resistive Input Condensation Mode.**

CONTACT ALARM - when the contact closes the "DI Contact Alarm" alarm message is displayed on the screen.

NETWORK; the digital input is used for network monitoring purposes.

CLOSE/OPEN FOR BOOST - when digital input activates the controller operates in Boost mode, until the digital input de-activates (only with CE-option). With the digital input boost the 'Target' text is replaced by 'Boost' text.

Note: Digital Input Delay Timer parameter applies to all settings.

Analogue Outputs

The controller has three analogue 0-10Vdc outputs that are typically linked to the control loop outputs. The following list states the possible options:

- NETWORK; As a network 0-10Vdc output variable
- HEATING STAGE 1; 0-10Vdc output is linked to Heating Stage 1
- HEATING STAGE 2; 0-10Vdc output is linked to Heating Stage 2
- COOLING STAGE 1; 0-10Vdc output is linked to Cooling Stage 1
- COOLING STAGE 2; 0-10Vdc output is linked to Cooling Stage 2
- EC FAN; 0-10Vdc output is linked to Fan Control Loop Output

- CO2; 0-10Vdc output is linked to CO2 Control Loop Output (CO2 Models)
- MAXIMUM VAV; 0-10Vdc linked to maximum of the Cooling stage 1 and CO2 loops
- MAXIMUM FAN; 0-10Vdc linked to maximum of the CO2 loop and fan loop
- HUMIDIFICATION; 0-10Vdc output is linked to Humidity Control Loop Output (RH Models)
- DE-HUMIDIFICATION; 0-10Vdc output is linked to De-Humidity Control Loop Output (RH Models)
- AMBER/RED; 0-10dc is @ 50% when Amber or Red alarm is active
- RED; 0-10Vdc is @ 100% when Red alarm is active
- HEATING STAGE 1 STAT; see RELAY OUTPUT / ON-OFF control chapter
- COOLING STAGE 1 STAT; see RELAY OUTPUT / ON-OFF control chapter
- FAN STAT; see RELAY OUTPUT / ON-OFF control chapter
- AUX LOOP; see AUXILIARY HEATING CONTROL LOOP chapter
- 6-PORT; see 6-PORT VALVE control chapter
- 6-PORT REVERSE; see 6-PORT VALVE control chapter (reverse operation)

Available with CE-Models

- LIGHTS; 0-10Vdc linked to the Lights Level
- BLINDS; 0-10Vdc linked to the Blinds Level

Analogue Output Scaling / Output Limitation

Each of the analogue outputs (Y1,Y2,Y3) can have

- Output minimum voltage (percentage)
- Output maximum voltage (percentage)

The connected control loop output 0..100% is then scaled from minimum voltage to maximum voltage.

For example in the EC fan control, if the fan is required to run always at minimum level, the minimum control output voltage can set to 10% (1V) and the maximum output 70% (7V). In this case the control loop output 0..100% is scaled to be 10..70% at the analogue output. This allows maximum noise levels to be limited and the fan to have a minimum fan speed.

The values are available via the communication network from network master read/write.

Relay Outputs / Fan Speed Control (TRC-2A3R/TRC-1A4R/TRC-H-3R2T)

TRC-(H)-2A3R, TRC-1A4R and TRC-H-3R2T have 3 relay outputs that be used to control 3-speed fans. The relay 1 is switched ON approx. 30% of fan demand, relay 2 is switched ON at approx. 60% of fan demand and relay 3 is switched ON approx 90% of fan demand. Only one relay is on at any given time. The relays are switched OFF approx 20% below the fan switch ON level.

NOTE: For the fan relay outputs to operate, the Y1 (Analogue Output Y1 Mode) has to be set to 'Modulating Fan' (default setting).

NOTE: TRC-H-2A3R/H-3R2T relays are rated 7A resistive. TRC-2A3R/1A4R relays are rated 0.5A resistive.

Relay Output / On-Off Control (TRC-1A4R)

TRC-1A4R have 4th 230Vac relay that can be used to switch 230Vac On/Off. The output can be used to switch heating valves, cooling valves or plant enable outputs. This is done by configuring the output Y2 setting to one of the following settings:-

HEATING STAGE 1 STAT; thermostatic switching of output, 100% (TRC-1A4R RLY4 via Y2 ON) when Heating1 Stage at 10% or over, switches back to 0% (TRC-1A4R RLY4 via Y2 OFF) when Heating1 Stage output 0%

COOLING STAGE 1 STAT; thermostatic switching of output, 100% (TRC-1A4R RLY4 via Y2 ON) when Cooling1 Stage at 10% or over, switches back to 0% (TRC-1A4R RLY4 via Y2 OFF) when Cooling1 Stage output 0%

FAN STAT; thermostatic switching of output, 100% (TRC-1A4R RLY4 via Y2 ON) when Fan Loop at 10% or over, switches back to 0% (TRC-1A4R RLY4 via Y2 OFF) when Fan Loop output 0%

As default for TRC-1A4R the Y2 has been configured as 'HEATING STAGE1 STAT'.

NOTE: With TRC-1A4R you can also configure Y1 to 'HEATING1 or COOLING1 STAT'. With this configuration RELAY3 becomes also as ON/OFF valve output. Therefore the TRC-1A4R controller can control both heating and cooling ON/OFF valves (and EC Fan via 0-10Vdc output).

PWM Control / Digital Outputs (TRC-1A2T/TRC-H-3R2T)

The TRC-1A2T/TRC-H-3R2T controller has two digital triac outputs. The digital outputs are used for PWM control for heating and cooling valves. The PWM period is set in the INPUTS/OUTPUTS PWM Period Setting. The below diagram illustrates the principle of the PWM control..

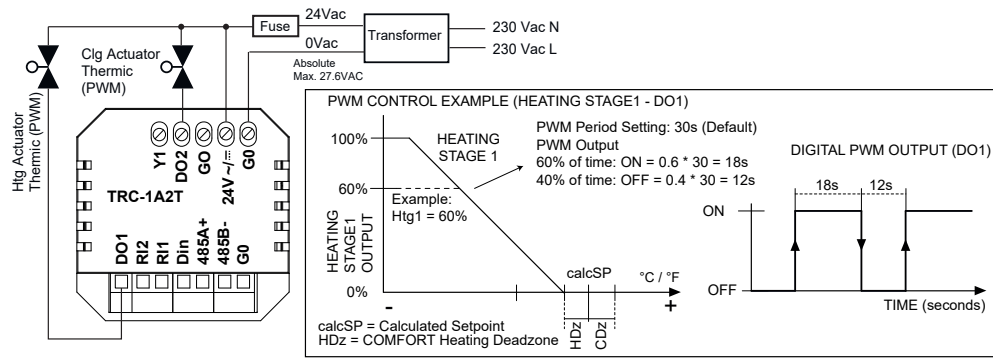

NOTE:With TRC-1A4R/3R2T analogue outputs Y2 & Y3 are not available. Y1 is available for EC Fan control (or other valid output control - see Y1 options). With TRC-H-3R2T the Y1 is set as default 'Modulating Fan', and the device does not have 0-10Vdc outputs.

NOTE:Please note that DO1 and DO2 are 24Vac Triacs switching to 0V. Please follow the above wiring diagram.

From firmware 4.15 onwards, the source of the Thermic actuator drive can be independently selected for each thermic output: The options are:-

- NETWORK; thermic level can be set from network
- HEATING STAGE 1; thermic output is linked to Heating Stage 1
- HEATING STAGE 2; thermic output is linked to Heating Stage 2
- COOLING STAGE 1; thermic output is linked to Cooling Stage 1
- COOLING STAGE 2; thermic output is linked to Cooling Stage 2
- CO2; thermic output is linked to CO2 Control Loop Output (CO2 Models)
- HUMIDIFICATION; thermic output is linked to Humidity Control Loop Output (RH Models)
- DE-HUMIDIFICATION; 0-10Vdc output is linked to De-Humidity Control Loop Output (RH Mod)
- AUX LOOP; see thermic output linked to AUXILIARY HEATING CONTROL LOOP chapter

NOTE: By setting the PWM period to 0, the output operates as ON/OFF. The output switches ON at 10% and OFF at 0%.

6-Port Control Mode

The TRC controller can be configured to control Belimo 6-Port valve by selecting **6-Port** or **6-Port Reverse** mode for the analogue output (Y1/Y2/Y3). The diagram below illustrates the operation.

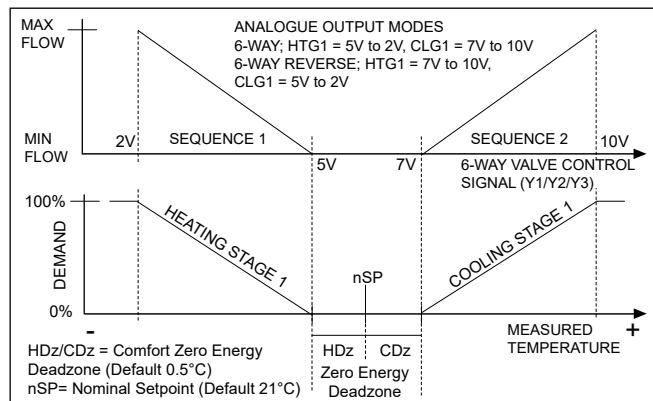

NOTE: Analogue Output Scaling/Anti-JAM is not available in the 6-Port and 6-Port Reverse modes. Number of Heating and Cooling Stages must be set at minimum to one.

AntiJAM Valve Exercise Function

If the AntiJAM function is enabled the controller monitors for inactivity. If the control outputs have been fully closed or fully open more than the AntiJAM period, the controller will open/close the outputs to by 30% for a short period of time. The AntiJAM function is enabled through the configuration parameters by selecting the required AntiJAM period by days.

Alarm Display

The TRC controller provides two Alarm Modules each of which can be configured to detect and display alarm condition on either CO2, Humidity or Temperature Sensor (internal or external depending on which is being used). The alarm function can be disabled by setting the alarm source as "NONE". Alarms are disabled by default.

Each Alarm has three alarm states – No Alarm, Amber and Red. When in alarm the alarm is displayed by alarm bell in ACTION CIRCLE. The ACTION CIRCLE rotates all active measurements so the alarm is displayed when the corresponding measurement is displayed.

CO2 AMBER ALARM

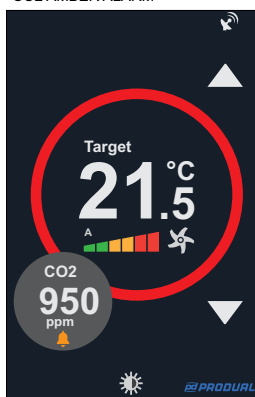

CO2 RED ALARM

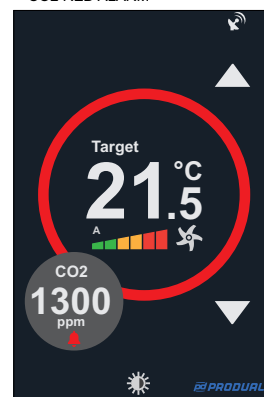

HIGH LIMIT ALARM

If the Red threshold is set higher than the amber threshold:

If Sensor >= Amber Threshold; Alarm = Amber

If Sensor >= Red Threshold; Alarm = Red

Hysteresis acts to prevent a return to a lower alarm level until the Sensor value falls to a Threshold - Hysteresis

LOW LIMIT ALARM

If the Amber threshold is set higher than the Red Threshold then:

If Sensor <= Amber Threshold; = Amber

If Sensor <= Red Threshold; Alarm = Red

Hysteresis acts to prevent a return to a lower alarm level until the Sensor value rises to a Threshold + Hysteresis.

Language Selection

The TRC user pages can be displayed in different languages by selecting the language from the System Configuration pages. By enabling the Show Language Swap parameter- the current language is displayed at the bottom left corner of the home screen. By clicking the icon it is possible to change the displayed language.

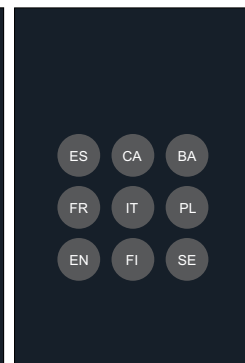
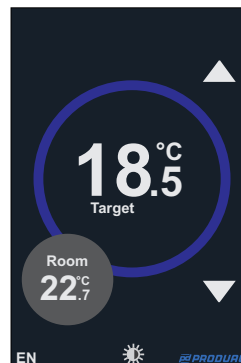

CLICK TO SET LANGUAGE

Sensor Fault Display

When entering FURTHER INFORMATION AND SETTINGS screen and a sensor/input fault is active, select the fault icon for more information.

The typical alarm reasons are:

- External sensor 1 (Res1) fault (when activated; out of range)
- External sensor 2 (Res1) fault (when activated; out of range)
- Built-in sensor fault
- Digital Input Alarm

FURTHER SETTINGS AND INFORMATION

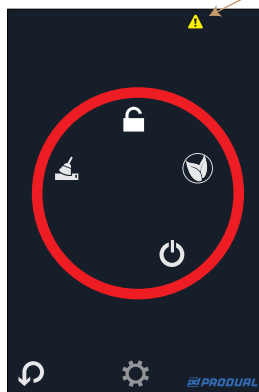

SELECT FAULT ICON FOR MORE INFORMATION

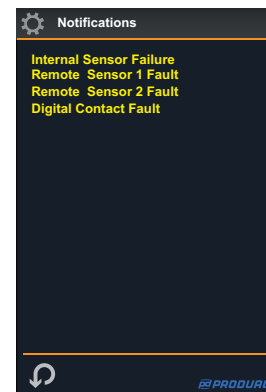

Controller Status Information Display

After entering CONFIGURATION PARAMETER GROUP screen and selecting the INFO icon it is possible to see the current status information of the controller. The page shows the current measurement and output information.

LIVE INFORMATION SCREEN

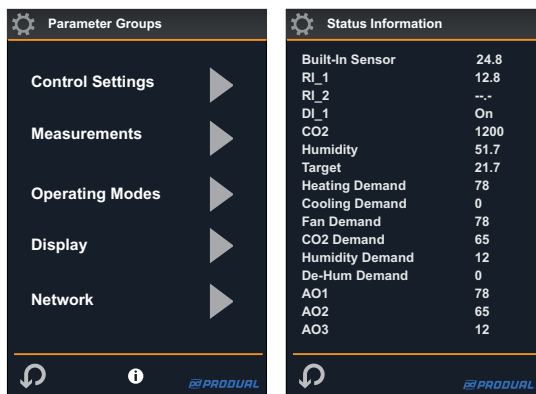

SELECT INFO ICON FOR

Configuration Parameters

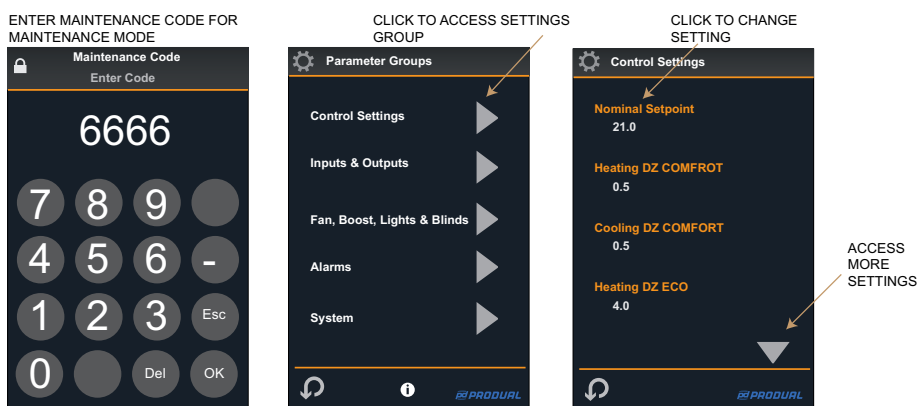

The TRC devices are configured to operate in different modes via the configuration parameters accessible through the maintenance mode.

To enter the maintenance mode click the COG WHEEL icon in the FURTHER SETTINGS SCREEN and enter the maintenance mode password (default 6666).

NOTE:The maintenance mode password can be changed in the configuration settings. Make sure that you note the new password if changed. If the Maintenance Code is set as 0000, the Maintenance Code entry screen is bypassed (i.e. no protection).

NOTE:It is good practice to reset the device after the configuration has been completed. Soft reset is automatically carried out after entering and exiting System configuration menu, or alternative power cycle the device.

CONTROL SETTINGS		
Parameter Name	Description	Range
Nominal SP	Nominal Setpoint (Temperature Control)	0.0...95.0°C/°F (Default 21.0°C)
Heating DZ COMFORT	Heating Deadzone in COMFORT mode	0.0...25.0°C/°F (Default 0.5°C)
Cooling DZ COMFORT	Cooling Deadzone in COMFORT mode	0.0...25.0°C/°F (Default 0.5°C)
Heating DZ ECO	Heating Deadzone in ECO Mode	0.0...25.0°C/°F (Default 4.0°C)
Cooling DZ ECO	Cooling Deadzone in ECO Mode	0.0...25.0°C/°F (Default 4.0°C)
Frost SP	Night Frost Setpoint (OFF Mode)	0.0...95.0°C/°F (Default 8.0°C)
Setpoint Adj. Max.	Temperature Setpoint Maximum Adjustment	0.0...20°C/°F (Default 3.0)
Setpoint Adj. Min.	Temperature Setpoint Minimum Adjustment	-20.0...0°C/°F (Default -3.0)
PB	Temperature Control Proportional Ban	1.0...50.0 °C/°F (Default 4.0)
IA	Integral Action time of the temperature control loop. Set to 0 to disable.	0..1,200 seconds (Default 600s)
Heating Stages	Number of Heating Stages	0 = None 1 = 1-Stage (Default) 2 = 2-Stages
Heating Stage 1 Dir.	Heating Stage 1 Direction	0 = Reverse (Default) 1 = Direct
Heating Stage 2 Dir.	Heating Stage 2 Direction	0 = Reverse (Default) 1 = Direct

CONTROL SETTINGS		
Parameter Name	Description	Range
Cooling Stages	Number of Cooling Stages	0 = None 1 = 1-Stage (Default) 2 = 2-Stages
Cooling Stage 1 Dir.	Cooling Stage 1 Direction	0 = Reverse 1 = Direct (Default)
Cooling Stage 2 Dir.	Cooling Stage 2 Direction	0 = Reverse 1 = Direct (Default)
Aux. SP	Auxiliary Heating Control Loop Setpoint	0.0...95.0°C/°F (Default 21.0°C)
Aux. PB	Auxiliary Heating Control Loop Proportional Band	1.0..50.0 °C/°F (Default 4.0)
Aux. IA	Auxiliary Heating Control Loop Integral Action	0..1,200 seconds (Default 600s)
Aux Dir.	Auxiliary Control Loop Actuator Direction (actuator direction, Direct = 0..100%, Reverse = 100..0%)	0 = Reverse Acting 1 = Direct Default
CO2 SP	CO2 Setpoint	0..5000ppm (Default 1,000 ppm)
CO2 PB	CO2 Proportional Band	10..5000 ppm (Default = 300 ppm)
CO2 IA	Integral Action time of the CO2 control loop. Set to 0 to disable.	0..10,000 seconds (Default 0)
CO2 Dir.	Direction of the CO2 control actuator.	0 = Reverse Acting 1 = Direct Acting (Default)
Humidity SP	Humidity Setpoint	0.0...100.0 %rH (Default 50%)
Humidity PB	Humidity Proportional Band	0.1...100.0 %rH (Default 20.0%)
Humidity IA	Integral Action time of the humidity control loop. Set to 0 to disable.	0..10,000 seconds (Default 0)
Humidification Dir.	Direction of the humidification output (actuator direction, Direct = 0..100%, Reverse = 100..0%).	0 = Reverse Acting 1 = Direct Acting (Default)
DeHum Dir.	Direction of the dehumidification output (actuator direction, Direct = 0..100%, Reverse = 100..0%).	0 = Reverse Acting 1 = Direct Acting (Default)
Limit High	High Limit Setpoint; High Limit Control	0.0..95.0°C/°F (Default 35.0°C)
Limit Low	Low Limit Setpoint; Low Limit Control	0.0..95.0°C/°F (Default 16.0°C)
Limit Ratio	Low/High Limit Ratio Note: 0.0 setting disables the reset control.	0.0..5.0 (0.0=Disabled, Default)
Changeover Low	Low Limit where the TRC Automatically Switches to Cooling Mode (Cold water supplied)	0.0..95.0°C/°F (Default 20.0°C)
Changeover High	High Limit where the TRC Automatically Switches to Heating Mode Mode (Hot water supplied)	0.0..95.0°C/°F (Default 25.0°C)

INPUTS & OUTPUTS		
Parameter Name	Description	Range
Room Sensor Text	Description for the Room Sensor (Built-In Sensor / RI1/RI2) Default; 1 = Room	0 = Disabled 1 = Room 2 = Floor
Floor Sensor Text	Description for the Floor Sensor (RI1/RI2) Default; 2 = Floor Note: Disabled removes Floor Sensor Text and Measurement from Display. The device may require Soft Reset after setting 'Disabled'. This is done by entering and exiting the System configuration menu.	3 = Outside 4 = Zone 1 5 = Zone 2 6 = Zone 3 7 = Bathroom 8 = Sauna 9 = Bedroom
Aux. Sensor Text	Description for the Aux Sensor (RI1 / RI2 / Network Value) Default; 3 = Outside Note: Disabled removes Aux Sensor Text and Measurement from Display. The device may require Soft Reset after setting 'Disabled'. This is done by entering and exiting the System configuration menu.	10 = Kitchen 11 = Cooler 12 = Flow 13 = Hot Water 14 = Tank 15 = Pool 16 = Cabin
Humidity Display	Enable / Disable Humidity Display (if option fitted)	0 = Disabled 1 = Enabled (default)
CO2 Display	Enable / Disable CO2 Display (if option fitted) From Fw 4.15 onwards.	0 = Disabled (default) 1 = Enabled
Aux. Loop Source	Source for the Auxiliary Loop Sensor (Display activated when valid temperature is sent)	0 = Built-In Sensor 1 = Network Temp

INPUTS & OUTPUTS		
Parameter Name	Description	Range
Digital Input Mode	Digital Input Operation	0 = Close for ECO (Default) 1 = Open for ECO 2 = Close for OFF 3 = Open for OFF 4 = Heating/Cooling Change-Over 5 = Disable Cooling 6 = Contact Alarm 7 = Network Measurement 8 = Close for BOOST (CE only) 9 = Open for BOOST (CE only) 13 = Condensation
Digital Input Delay	Digital Input Delay Timer (transition from active to non-active)	0..28,800 seconds (Default 0s)
RI1 Mode	Resistive Input 1 Mode	0 = Disabled (default) 1 = Room (NTC10 Temp Control) 2 = Floor (NTC10 Floor Low/High Limit Control) 3 = Aux. Loop 4 = Heating / Cooling (NTC10 Change-Over) 5 = Network NTC10 6 = Network 0-10V 7 = CO2; 0..2000ppm = 0-10V (AI-option) 8 = Main Loop (Control Temp; 0..50°C = 0-10V; AI-option) 9 = Close for ECO (DI-mode) 10 = Open for ECO (DI-mode) 11 = Close for OFF (DI-mode) 12 = Open for OFF (DI-mode) 13 = Condensation 14 = Network DI
RI2 Mode	Resistive Input 2 Mode	
Internal Sensor Cal.	Internal Sensor One Point Compensation	-10.0..+10.0 °C/°F
RI1 Cal.	Sensor Connected to RI1 Calibration	-10.0..+10.0 °C/°F
RI2 Cal.	Sensor Connected to RI1 Calibration	-10.0..+10.0 °C/°F
CO2 Cal.	CO2 Sensor Calibration (CO2 Models)	-500...+500 ppm
Humidity Cal.	Humidity Calibration (RH Models)	-10.0..+10.0 % rH
Y1	Analogue Output Y1 Mode Default: Modulating Fan NOTE: With TRC-2A3R, 1A4R and 3R2T do not change this setting - leave to default.	0 = Network Value 1 = Heating Stage 1 2 = Heating Stage 2 3 = Cooling Stage 1 4 = Cooling Stage 2 5 = Modulating Fan (EC) 6 = CO2 Control 7 = Maximum VAV 8 = Maximum Fan 9 = Humidification 10 = De-humidification 11 = Light Control 12 = Blinds Control 13 = Amber / Red 14 = Red 15 = Heating Stage1 Sta 16 = Cooling Stage1 Stat 17 = Fan Stat 18 = Aux Loop 19 = 6-Port (Valve) 20 = 6-Port Reverse (Valve)
Y2	Analogue Output Y2 Mode Default: Heating Stage 1 TRC-1A4R Default: Heating Stat1 NOTE: Not available with TRC-1A2T/3R2T.	
Y3	Analogue Output Y3 Mode Default: Cooling Stage. NOTE: Not available with TRC-1A2T/3R2T.	
Y1 Min.	Analogue Output Y1 Minimum Value	0..100%(0% = default)
Y1 Max.	Analogue Output Y1 Minimum Value	0..100% (100% = default)
Y2 Min.	Analogue Output Y2 Minimum Value	0..100%(0% = default)
Y2 Max.	Analogue Output Y2 Minimum Value	0..100% (100% = default)
Y3 Min.	Analogue Output Y3 Minimum Value	0..100%(0% = default)
Y3 Max.	Analogue Output Y3 Minimum Value	0..100% (100% = default)
Anti-JAM	Valve Exercise	0..14 Days (default 0 = disabled)
PWM1 Period	PWM1 Period for DO1 (TRC-1A2T/TRC-H-3R2T)	0..120 Seconds (default 30)

INPUTS & OUTPUTS		
Parameter Name	Description	Range
PWM2 Period	PWM2 Period for DO2 (TRC-1A2T/TRC-H-3R2T) From Fw 4.15 onwards	0..120 Seconds (default 30) 0 = On/Off Control
Thermic 1 Mode	Thermic 1 Control Mode (Controls DO1) Default; 1 = Heating Stage 1 From Fw 4.15 onwards	0 = Network Value 1 = Heating Stage 1 2 = Heating Stage 2 3 = Cooling Stage 1 4 = Cooling Stage 2
Thermic 2 Mode	Thermic 2 Control Mode (Controls DO2) Default; 2 = Cooling Stage 1 From Fw 4.15 onwards	5 = CO2 Control 6 = Humidification 7 = De-humidification 8 = Aux Control Demand

FAN, BOOST, LIGHTS & BLINDS		
Parameter Name	Description	Range
Fan Speed Display	Selecting the Fan Speed (User Adjustment) for the Display Note: Modes 2,3,4 set the number of steps the user can manually adjust the fan speed.	0 = None (Default) 1 = No Input (no user adj.) 2 = 0 - 1 (0%, 100%) 3 = 0 - 1 - 2 (0%, 50%, 100%) 4 = 0 - 1 - 2 - 3 (0%, 33%, 66%, 100%) 5 = 0 - 1 - 2 - 3 - 4 - 5 - 6
Fan Speed Source	Fan Speed Control Source (The fan speed follows the selected control loop output. The minimum Fan Level parameter applies in operation)	0 = Heating 1 and Cooling 1 Stage (Default) 1 = Heating Stage 1 2 = Cooling Stage 1 3 = Heating and Cooling Stage 2 4 = Heating Stage 2 5 = Cooling Stage 2 6 = CO2 7 = Humidification 8 = De-Humidification 9 = Maximum VAV (Cooling/CO2) 10 = Maximum Temp/Hum 11 = Aux. Loop
Min Fan Level	Fan Speed Minimum Active Level	0...100% (Default 0%)
Fan Off Delay	Fan Switch Off Delay when Fan Speed Source Demand < Min Fan Level. Note: Only active if Min Fan Level is set.	0...28,800 seconds (Default = 0) 0 = Infinite
Boost Time	Boost Mode Running Time	0 = Permanent 1..480 minutes (Default 0)
Boost Target	Boost Button Target Operation	0 = Boost Disabled 1 = Heating Stage 1 (default) 2 = Heating Stages 1&2 3 = Cooling Stage 1 4 = Cooling Stages 1&2 5 = Humidity Control Loop 6 = De-Humidity Loop 7 = CO2 Loop 8 = Fan 9 = Aux. Loop
Lights Delay Time	Delay Time for Lights Switch Off	0..1,800 Seconds (Default 30)
Enable Lights	Enable Lights Icon and Operating Mode	0 = Disabled (default) 1 = 0 - 1 2 = 0 - 1 - 2 3 = 0 - 1 - 2 - 3
Lights Interlock	Select Lights Interlocked Operating Mode	0 = Disabled 1 = COMFORT 2 = COMFOR + ECO
Blinds Mode	Enable Blinds Icon and Operating Mode	0 = Disabled (default) 1 = Enabled, ON/OFF 2 = Enabled, 4-Steps

ALARMS		
Parameter Name	Description	Range
Alarm 1 Source	Source for the Alarm Display	0 = CO2 Sensor 1 = Room (Temperature) 2 = Humidity 3 = None (Default)
Alarm 1 Amber Threshold	Alarm 1 Amber Backlight Switching Point	0..5000 (Default 0)
Alarm 1 Red Threshold	Alarm 1 Amber Backlight Switching Point	0..5000 (Default 0)
Alarm 1 Hysteresis	Hysteresis for Alarm 1	0..5000 (Default 0)
Alarm 2 Source	Source for the Alarm Display	0 = CO2 Sensor 1 = Room (Temperature) 2 = Humidity 3 = None (Default)
Alarm 2 Amber Threshold	Alarm 2 Amber Backlight Switching Point	0..5000 (Default 0)
Alarm 2 Red Threshold	Alarm 2 Amber Backlight Switching Point	0..5000 (Default 0)
Alarm 2 Hysteresis	Hysteresis for Alarm 2	0..5000 (Default 0)

SYSTEM		
Parameter Name	Description	Range
Address	Modbus Address (Only Modbus versions) BACnet MAC Address (Only BACnet versions)	0..247 (Default 1) 0..127 (Default 1)
Baud Rate (Only Modbus/BACnet versions)	Modbus / BACnet Baud Rate	0 = 9600 (Default) 1 = 19200 2 = 38400 3 = 57600 4 = 76800
Parity (Only Modbus/BACnet versions)	Parity	0 = None (Default) 1 = Odd 2 = Even
Stop Bits (Only Modbus/BACnet versions)	Stop Bits	0 = 1 Stop Bit (Default) 1 = 2 Stop Bits
Device ID (Only BACnet versions)	BACnet Device ID	0..4,194,303 (Default Auto=651001)
Service Pin (Only BACnet versions)	Bacnet Service Pin (when activated the device sends BACnet I-AM message)	0 = Disabled (default) 1 = Enabled
Brightness	Backlight Brightness	0..20 (default 5)
Show Unit Swap	Shows the Fahrenheit / Celsius Unit Selection Button	0 = Disabled (default) 1 = Enabled
Lock Mode	Lock Operation	0 = Disabled (default) 1 = On /Off Only (Lights & Blinds) 2 = Temp Adjust Only Available 3 = No Input - All Buttons Disabled
Lock Code	Lock Mode Password	0000 - 9999 (default 0000)
Maintenance Code	Maintenance Mode Password	0000 - 9999 (default 6666)
Staff Code	Staff Page Password - Access Password to Further Settings Screen	0000 - 9999 (default 0000 = disabled)
Screen Refresh Rate	Refresh Rate of the LCD Screen	0 = Fast (default) 1 = Medium 2 = Slow
Screen Cycle Speed	Cycle Speed of Measurements in the ACTION RING Fast = 4.3 secs, Medium = 7.8 secs, Slow = 10.8 secs	0 = Fast 1 = Medium (default) 2 = Slow
Native Units (Defaults)	Selects either Fahrenheit / Celsius as Native Units NOTE: RELOADS DEFAULTS	C = Celsius (default) F = Fahrenheit

SYSTEM		
Parameter Name	Description	Range
Language	Language	EN = English (Default) FI = Finnish SE = Swedish FR = French PL = Polish IT = Italian ES = Spanish CA = Catalan BA = Euskera
Show Language Swap	Enables Language Selection Button on the Home Screen	0 = Disabled (default) 1 = Enabled
Reload Default	Reload Default Settings	0 = Off (default) 1 = On
Version	Software Version	x.xx (BACnet/Modbus)

Parameter Storage

The configuration parameters are stored in the non-volatile memory. When the changes are carried out via the display, the parameters are stored in the non-volatile memory when the controller returns to a normal display mode. If the changes are carried out over the network (Modbus or BACnet), then "NonVol Update" register/object is required to be forced on to save the changes. The register will automatically return to normal state

Modbus Registers

The controller supports the following Modbus registers and function codes. The default communication speed is 9600 bps, 8 data bits, Parity None and 1 Stop Bit. The default Modbus Slave address is 1. The device Parity can be changed between Odd, None and Even. The baud rate is selectable between 9600, 19200, 38400, 57600 and 76800 bps. The table shows the register offsets starting from 0 (0 Base) register address. For example, the Temperature is read from Modbus register 0 using Function Code 04. Some Modbus masters will require one to be added to Modbus registers (i.e. 1 Base). In this case Function Code 04, register 101 needs to be entered.

Register	Parameter Description	Data Type	Raw Data	Range
	FUNCTION CODE 01 - READ COILS FUNCTION CODE 05 - WRITE SINGLE COIL FUNCTION CODE 15 - WRITE MULTIPLE COILS			
100	OFF Mode Override		0..1	Off - On
101	ECO Mode Override		0..1	Off - On
102	Heating/Cooling Mode (change-over mode)		0..1	0 = Heating, 1 = Cooling
	FUNCTION CODE 02 - READ DISCRETE INPUTS (Add 10,000 for Modicon Addressing)			
100	Digital Input Status (DI1)		0..1	Off - On
101	Boost Status		0..1	Off - On
102	Screen Lock Status		0..1	Off - On
103	Digital Output 1 (TRC-1A2T)		0..1	Off - On
104	Digital Output 2 (TRC-1A2T)		0..1	Off - On
105	Digital Input 2 (RI1 Condensation Mode Status)		0..1	Off - On
106	Digital Input 3 (RI2 Condensation Mode Status)		0..1	Off - On
	FUNCTION CODE 04 - READ INPUT REGISTERS (Add 30,000 for Modicon Addressing)			
100	Built-In Temperature Measurement	Signed 16	-400...3020	-40.0...150.0°C (-40.0...302.0°F)
101	Remote Sensor 1 Measurement (Resistive Input 1)	Signed 16	-400...3020	-40.0...150.0°C (-40.0...302.0°F)
102	Remote Sensor 2 Measurement (Resistive Input 2)	Signed 16	-400...3020	-40.0...150.0°C (-40.0...302.0°F)
103	Current Calculated Setpoint	Signed 16	-400...3020	-40.0...150.0°C (-40.0...302.0°F)
104	Device Current Mode	Unsigned 16	0..3	0 = Comfort 1 = ECO 2 = OFF 3 = Boost
105	Relative Humidity Measurement	Unsigned 16	0..1000	0..100.0 %rH

Register	Parameter Description	Data Type	Raw Data	Range
106	CO2 Measurement	Unsigned 16	0..5000	0..5,000 ppm
107	Analogue Output Y1	Unsigned 16	0..1000	0..100.0 %
108	Analogue Output Y2	Unsigned 16	0..1000	0..100.0 %
109	Analogue Output Y3	Unsigned 16	0..1000	0..100.0 %
110	Alarm 1 State	Unsigned 16	0..3	0 = Normal (No Alarm) 1 = Amber Alarm 2 = Red Alarm
111	Alarm 2 State	Unsigned 16	0..3	0 = Normal (No Alarm) 1 = Amber Alarm 2 = Red Alarm
112	Blinds Level	Unsigned 16	0..1,000	0..100.0 %
113	Lights Level	Unsigned 16	0..1,000	0..100.0 %
114	Analogue Input 1 (RI1) Measurement (0-10V, Option)	Unsigned 16	0..1000	0..100.0 %
115	Analogue Input 2 (RI2) Measurement (0-10V, Option)	Unsigned 16	0..1000	0..100.0 %
116	Fan Speed Demand (for TRC-2A3R)	Unsigned 16	0..1000	0..100.0 %
117	Thermic1 Demand	Unsigned 16	0..1000	0..100.0 %
118	Thermic2 Demand	Unsigned 16	0..1000	0..100.0 %
200	Firmware Versions	Unsigned 16	N/A	N/A
FUNCTION CODE 03 - READ HOLDING REGISTERS (For Modicon Addressing Add 40,000)				
FUNCTION CODE 06 - WRITE SINGLE HOLDING REGISTER				
FUNCTION CODE 16 - WRITE MULTIPLE HOLDING REGISTERS				
100	Nominal Setpoint	Unsigned 16	0...950	0.0...95.0°C/°F (Default 20°C)
101	Heating Comfort Deadzone	Unsigned 16	0...250	0.0...25.0°C/°F (Default 0.5°C)
102	Cooling Comfort Deadzone	Unsigned 16	0...250	0.0...25.0°C/°F (Default 0.5°C)
103	ECO Heating Deadzone	Unsigned 16	0...250	0.0...25.0°C/°F (Default 4.0°C)
104	ECO Cooling Deadzone	Unsigned 16	0...250	0.0...25.0°C/°F (Default 4.0°C)
105	Frost Setpoint	Unsigned 16	0...950	0.0...95.0°C/°F (Default 8°C)
106	Setpoint Adjust Minimum	Signed 16	-200..0	-20.0..0.0 °C/°F (Default -3.0)
107	Setpoint Adjust Maximum	Signed 16	0..200	0.0..20.0 °C/°F (Default 3.0)
108	Temperature Control Proportional Band	Unsigned 16	10..500	1.0...50.0°C/°F (Default 4°C)
109	Temperature Control Integral Action Time	Unsigned 16	0..1200	0..1200 seconds (600s default)
110	Number of Heating Stages	Unsigned 16	0..2	0 = None 1 = 1-Stage (Default) 2 = 2-Stages
111	Heating Stage 1 Direction	Unsigned 16	0..1	0 = Reverse (Default) 1 = Direct
112	Heating Stage 2 Direction	Unsigned 16	0..1	0 = Reverse (Default) 1 = Direct
113	Number of Cooling Stages	Unsigned 16	0..2	0 = None 1 = 1-Stage (Default) 2 = 2-Stages
114	Cooling Stage 1 Direction	Unsigned 16	0..1	0 = Reverse 1 = Direct (Default)
115	Cooling Stage 2 Direction	Unsigned 16	0..1	0 = Reverse 1 = Direct (Default)
116	High Limit Setpoint	Unsigned 16	0...950	0..95°C/°F (Default 35.0°C)
117	Low Limit Setpoint	Unsigned 16	0...950	0..95°C/°F (Default 16.0°C)
118	Limit Ratio	Unsigned 16	0..50	0.0..5.0 (0.0=Disabled, Default)
119	CO2 Control Setpoint	Unsigned 16	0..5,000	0..5000ppm (Default 1,000 ppm)
120	CO2 Proportional Band	Unsigned 16	10..5,000	10..5000 ppm (Default = 300 ppm)
121	CO2 Control Integral Action	Unsigned 16	0..10,000	0..10,000 seconds (Default 0)

Register	Parameter Description	Data Type	Raw Data	Range
122	CO2 Output Direction	Unsigned 16	0..1	0 = Reverse Acting 1 = Direct Acting (Default)
123	Humidity Control Setpoint	Unsigned 16	0..1000	0.0...100.0 %rH (Default 50%)
124	Humidity Proportional Band	Unsigned 16	10..1000	1.0...100.0 %rH (Default 20.0%)
125	Humidity Control Integral Action	Unsigned 16	0..10,000	0..10,000 seconds (Default 0)
126	Humidification Output Direction	Unsigned 16	0..1	0 = Reverse Acting 1 = Direct Acting (Default)
127	De-Humidification Output Direction	Unsigned 16	0..1	0 = Reverse Acting 1 = Direct Acting (Default)
128	Fan Speed Display	Unsigned 16	0..5	0 = No Display (Default) 1 = Display Only (no user adj.) 2 = 0 - 1 (0%, 100%) 3 = 0 - 1 - 2 (0%, 50%, 100%) 4 = 0 - 1 - 2 - 3 (0%, 33%, 66%, 100%) 5 = 0 - 1 - 2 - 3 - 4 - 5 - 6
129	Fan Speed Source	Unsigned 16	0..11	0 = Heating 1 and Cooling 1 Stage (Default) 1 = Heating Stage 1 2 = Cooling Stage 1 3 = Heating and Cooling Stage 2 4 = Heating Stage 2 5 = Cooling Stage 2 6 = CO2 7 = Humidification 8 = De-Humidification 9 = Maximum VAV (Cooling/CO2) 10 = Maximum Temp/Hum 11 = Aux. Loop
130	Min Fan Level	Unsigned 16	0..100	0...100% (Default 0%)
131	Y1 Output Mode Default: Modulating Fan	Unsigned 16	0..20	0 = Network Value 1 = Heating Stage 1 2 = Heating Stage 2 3 = Cooling Stage 1 4 = Cooling Stage 2 5 = Modulating Fan (EC) 6 = CO2 Control 7 = Maximum VAV 8 = Maximum Fan 9 = Humidification 10 = De-humidification 11 = Light Control 12 = Blinds Control 13 = Amber / Red 14 = Red 15 = Heating1 Sta 16 = Cooling1 Stat 17 = Fan Stat 18 = Aux. Loop 19 = 6-Port (Valve) 20 = 6-Port Reverse (Valve)
132	Y2 Output Mode Default: Heating Stage 1 TRC-1A4R Default: Heating1 Stat	Unsigned 16	0..20	
133	Y3 Output Mode Default: Cooling Stage 1	Unsigned 16	0..20	
134	Analogue Output Y1 Override Value	Unsigned 16	0..1000	0..100% (0..10.0V) - Default 0
135	Analogue Output Y2 Override Value	Unsigned 16	0..1000	0..100% (0..10.0V) - Default 0
136	Analogue Output Y3 Override Value	Unsigned 16	0..1000	0..100% (0..10.0V) - Default 0
137	Y1 Minimum Output	Unsigned 16	0..1000	0...100.0 % (Default 0.0%)
138	Y1 Maximum Output	Unsigned 16	0..1000	0...100.0 % (Default 100.0%)
139	Y2 Minimum Output	Unsigned 16	0..1000	0...100.0 % (Default 0.0%)
140	Y2 Maximum Output	Unsigned 16	0..1000	0...100.0 % (Default 100.0%)
141	Y3 Minimum Output	Unsigned 16	0..1000	0...100.0 % (Default 0.0%)
142	Y3 Maximum Output	Unsigned 16	0..1000	0...100.0 % (Default 100.0%)
143	Anti-JAM Time-out	Unsigned 16	0..14	0..14 Days 0 = Disabled (Default)

Register	Parameter Description	Data Type	Raw Data	Range
144	RI1 Mode	Unsigned 16	0..14	0 = Disabled (default) 1 = Room (NTC10 Control) 2 = Floor (NTC10 High/Low Lim) 3 = Aux. Loop 4 = Heating / Cooling (NTC10 Change-over) 5 = Network NTC10 6 = Network 0-10V 7 = CO2 0-10V (0..2000 =0-10V) 8 = Main Loop (0..50°C=0-10V) 9 = Close for ECO (DI-mode) 10 = Open for ECO (DI-mode) 11 = Close for OFF (DI-mode) 12 = Open for OFF (DI-mode) 13 = Condensation 14 = Network DI
145	RI2 Mode	Unsigned 16	0..14	
146	Outside Temperature Source	Unsigned 16	0..1	0 = Built-In Sensor (Default) 1 = Network Sensor
147	Outside Air Temperature Network Write Note: If Outside Temperature Source is set to 1, and a valid (within range) value is sent to this parameter the touchscreen starts to show Outside temperature in the SMALL ACTION CIRCLE.	Signed 16	-580...1220	-58.0...122.0°C/°F (Default 0.0)
148	Digital Input Mode	Unsigned 16	0..9	0 = Close for ECO (Default) 1 = Open for ECO 2 = Close for OFF 3 = Open for OFF 4 = Heating/Cooling Change-Over 5 = Disable Cooling 6 = Contact Alarm 7 = Network Measurement 8 = Close for BOOST (CE only) 9 = Open for BOOST (CE only)
149	Digital Input Delay	Unsigned 16	0..28,800	0..28,800 seconds (Default 0s)
150	Internal Sensor Calibration	Signed 16	-100..+100	-10.0...+10.0 °C/°F
151	RI1 Calibration	Signed 16	-100..+100	-10.0...+10.0 °C/°F
152	RI2 Calibration	Signed 16	-100..+100	-10.0...+10.0 °C/°F
153	CO2 Calibration	Signed 16	-500...+500	-500...+500 ppm
154	Humidity Calibration	Signed 16	-100..+100	-10.0...+10.0 % rH
155	Lock Mode	Unsigned 16	0..4	0 = Lock mode disabled (default) 1 = On/Off workable only 2 = Temp settings only available 3 = All buttons disabled
156	Lock Mode Password	Unsigned 16	0..9999	0000...9999
157	Boost Time	Unsigned 16	0..480	0 = Permanent (Default 0) 1..480 minutes
158	Boost Target	Unsigned 16	0..8	0 = Boost Disabled 1 = Heating Stage 1 (default) 2 = Heating Stages 1&2 3 = Cooling Stage 1 4 = Cooling Stages 1&2 5 = Humidity Control Loop 6 = De-Humidity Loop 7 = CO2 Loop 8 = Fan
159	Lights Delay Time	Unsigned 16	0..1800	0..1,800 Seconds (Default 30)
160	Lights Mode	Unsigned 16	0..3	0 = Disabled (default) 1 = 0-1 2 = 0-1-2 3 = 0-1-2-3
161	Lights Interlock	Unsigned 16	0..2	0 = Disabled (default) 1 = COMFORT 2 = COMFORT + ECO
162	Blinds Mode	Unsigned 16	0..2	0 = Disabled (default) 1 = Enabled, ON/OFF 2 = Enabled, 4-Steps
163	Brightness (Backlight Level)	Unsigned 16	0..20	0..20 (default 5)

Register	Parameter Description	Data Type	Raw Data	Range
164	Display Humidity	Unsigned 16	0..1	0 = Disabled 1 = Enabled (default)
165	Show Swap Temperature Units Icon	Unsigned 16	0..1	0 = Disabled (default) 1 = Enabled
166	Zone 1 Room Sensor Text Default; 1 = Room (Option 0 available from Fw 4.14 onwards)	Unsigned 16	0..16	0 = Disabled 1 = Room 2 = Floor 3 = Outside 4 = Zone 1 5 = Zone 2 6 = Zone 3 7 = Bathroom 8 = Sauna 9 = Bedroom 10 = Kitchen 11 = Cooler 12 = Flow 13 = Hot Water 14 = Tank 15 = Pool 16 = Cabin
167	Zone 2 Floor Sensor Text Default: 2 = Floor	Unsigned 16	0..16	
168	Zone 3 Outside Sensor Text Default: 3 = Outside	Unsigned 16	0..16	
169	Alarm 1 Source	Unsigned 16	0..3	0 = CO2 1 = Room (Temperature) 2 = Humidity 3 = None (Default)
170	Alarm 1 Amber Switching Point	Unsigned 16	0..5000	0..5000 (Default 0)
171	Alarm 1 Red Switching Point	Unsigned 16	0..5000	0..5000 (Default 0)
172	Alarm 1 Hysteresis	Unsigned 16	0..5000	0..5000 (Default 0)
173	Alarm 2 Source	Unsigned 16	0..3	0 = CO2 1 = Room (Temperature) 2 = Humidity 3 = None (Default)
174	Alarm 2 Amber Switching Point	Unsigned 16	0..5000	0..5000 (Default 0)
175	Alarm 2 Red Switching Point	Unsigned 16	0..5000	0..5000 (Default 0)
176	Alarm 2 Hysteresis	Unsigned 16	0..5000	0..5000 (Default 0)
177	Override Lights Notes: After overriding the level the parameter returns to 0. The lights object takes the last action (network or user). Notes: Override Level 1 is the next level after 0% and depends on the configuration. For On/Off = 100%, for 3-levels = 50%, for 4-levels = 33%. And so on.	Unsigned 16	0..5	0 = None (default) 1 = Override Level (0%) 2 = Override Level 1 (100%-On/Off, 50%-3 Levels, 33% - 4 Levels) 3 = Override Level 2 (100%-3-Levels, 66% - 4 Levels) 4 = Override Level 3 (100% - 4 Levels)
178	Override Blinds Notes: After overriding the level the parameter returns to 0. The blinds object takes the last action (network or user). Notes: Override Level 1 is 100% for On/Off config, 25% for 4-steps config.	Unsigned 16	0..5	0 = None (default) 1 = Override Level 0 (0%) 2 = Override Level 1 (25/100%) 3 = Override Level 2 (50%) 4 = Override Level 3 (75%) 5 = Override Level 4 (100%)
179	Override Lock Mode Notes: After overriding the Lock to On/Off the parameter returns to 0.	Unsigned 16	0..2	0 = None (default) 1 = Override On 2 = Override Off
180	Maintenance Mode Password	Unsigned 16	0..9999	0000...9999 (default 6666)
181	Staff Code	Unsigned 16	0..9999	0000...9999 (default 0000)
182	PWM1 Cycle (Only TRC-1A2T/3R2T)	Unsigned 16	0..120	0..120 None (default 30, 0=on/off)
183	Digital Output 1 Network Override (Overrides DO1 directly, local, only TRC-1A2T)	Unsigned 16	0..2	0 = No Override (Default) 1 = Override Output On 2 = Override Output Off
184	Digital Output 2 Network Override (Overrides DO2 directly, local, only TRC-1A2T)	Unsigned 16	0..2	0 = No Override (Default) 1 = Override Output On 2 = Override Output Off
185	Heating/Cooling Changeover Min Temperature	Unsigned 16	0...950	0.0...95.0°C/°F (Default 20°C)
186	Heating/Cooling Changeover Max Temperature	Unsigned 16	0...950	0.0...95.0°C/°F (Default 25°C)

Register	Parameter Description	Data Type	Raw Data	Range
187	Fan Speed Override	Unsigned 16	0..7	0 = Auto 1 = Manual Off 2 = Manual Level 1 3 = Manual Level 2 4 = Manual Level 3 5 = Manual Level 4 6 = Manual Level 5 7 = Manual Level 6
188	Fan Off Delay - Only applicable if Min Fan Level is set.	Unsigned 16	0..28,800	0..28,800seconds (Default 0) 0 = Infinite Delay
189	Aux Heating Loop Setpoint	Unsigned 16	0..950	0.0..95.0°C/°F (Default 20°C)
190	Aux Heating Loop Proportional Band	Unsigned 16	10..500	1.0..50.0°C/°F (Default 4°C)
191	Aux Heating Loop Integral Action Time	Unsigned 16	0..1200	0..1200 seconds (600s default)
192	Aux Loop Actuator Direction (actuator direction, Direct = 0..100%, Reverse = 100..0%)	Unsigned 16	0..1	0 = Reverse Action (100-0%) 1 = Direct (0-100% Default)
193	PWM2 Cycle (Only TRC-1A2T/3R2T fr. Fw4.14)	Unsigned 16	0..120	0..120 None (default 30, 0=on/off)
194	Thermic 1 Mode Default: Heating Stage 1 (From Fw 4.15 onwards)	Unsigned 16	0..8	0 = Network Value 1 = Heating Stage 1 2 = Heating Stage 2 3 = Cooling Stage 1 4 = Cooling Stage 2 5 = CO2 Control 6 = Humidification 7 = De-humidification 8 = Aux Control Demand
195	Thermic 2 Mode Default: Cooling Stage 1 (From Fw 4.15 onwards)	Unsigned 16	0..8	
196	Thermic 1 Override Value (from Fw 4.15)	Unsigned 16	0..1000	0..100% - Default 0
197	Thermic 1 Override Value (from Fw 4.15)	Unsigned 16	0..1000	0..100% - Default 0
200	Modbus Address	Unsigned 16	0..247	0..247 (Default 1)
201	Modbus Baud Rate	Unsigned 16	0..4	0 = 9600 (Default) 1 = 19200 2 = 38400 3 = 57600 4 = 76800
202	Modbus Parity	Unsigned 16	0..2	0 = None (Default) 1 = Odd 2 = Even
203	Stop Bits	Unsigned 16	0..1	0 = 1 Stop Bit (Default) 1 = 2 Stop Bits
300	Force Reset	Unsigned 16	0..1	0 = Normal 1 = Force Reset
301	Non Volatile Memory Update	Unsigned 16	0..1 Note 3	0 = Normal 1 = Update
303	Force Factory Defaults	Unsigned 16	0..1	0 = Normal 1 = Force Defaults
304	Screen Refresh Rate	Unsigned 16	0..2	0 = Fast (Default) 1 = Medium 2 = Slow
306	Language	Unsigned 16	0..8	0 = English (Default) 1 = Finnish 2 = Swedish 3 = French 4 = Polish 5 = Italian 6 = Spanish 7 = Catalan 8 = Euskera

BACnet Standard Object Types Supported

No dynamic Creation or Deletion supported. Objects, and object instances, are assigned to fixed functions within the proprietary control application of the product as follows

Object	Number Of Instances	Instance Assignments
Device Object	1	
Analog Input	11	AI(0) –Built-In Sensor AI(1) - RI_1 (RI1 Temperature / AI1) AI(2) - RI_2 (RI2 Temperature / AI2) AI(3) - Target (Calculated Setpoint) AI(4) - Humidity AI(5) - CO2 AI(6) - Fan Demand AI(7) - Lights Demand AI(8) - Blinds Demand AI(9) - Thermic1 Demand AI(10) - Thermic2 Demand
Analogue Value	23	AV(0) - Nominal Setpoint AV(1) – Heating DZ Comfort AV(2) – Cooling DZ Comfort AV(3) – Heating DZ ECO AV(4) – Cooling DZ ECO AV(5) – Frost SP AV(6) – Y1 Minimum AV(7) – Y1 Maximum AV(8) – Y2 Minimum AV(9) – Y2 Maximum AV(10) – Y3 Minimum AV(11) – Y3 Maximum AV(12) - PB (Proportional Band) AV(13) – IA (Integral Action) AV(14) – Brightness (LCD) AV(15) - Network Temp. AV(16) – CO2 SP (CO2 Setpoint) AV(17) – Humidity SP (Humidity Setpoint) AV(18) – Y1 Output ³ AV(19) – Y2 Output ³ AV(20) – Y3 Output ³ AV(22) - Thermic1 Value (fw 4.14) AV(23) - Thermic2 Value (fw 4.14)
Binary Input	4	BI(0) – DI_1 (Digital Input 1) BI(1) – Boost Status BI(2) - DI_2 (Resistive Input 1 - Condensation Mode) BI(3) - DI_2 (Resistive Input 2 - Condensation Mode)
Binary Output	7	BO(0) - OFF Status ¹ BO(1) - ECO Status ¹ BO(2) – Lock ¹ BO(3) – Change-Over BO(4) - Update Nonvol BO(5) - DO_1 (Digital Output 1 TRC-1A2T) BO(6) - DO_2 (Digital Output 2 TRC-1A2T)
MultiState Value	4	MSV(0) - Device Mode (1=Comfort, 2=ECO, 3=OFF, 4 = Boost) MSV(1) - Alarm (Binary Coded - Add 1 to bit values) Bit 0 - Internal NTC (1) Bit 1 - RI1 (2) Bit 2 - RI2 (4) Bit 3 - Humidity Sensor (8) Bit 4 - DI1 (16) MSV(2) - Light Level (1=Off, 2=Level_1, 3=Level_2, 4=Level_3) ² MSV(3) - Blinds Level (1=Off, 2=Level_1, 3=Level_2, 4=Level_3, 5=Level_4) ² MSV(4) - Fan Speed Override (1 = Auto, 2 = Man_0, 3=Man_1, 4=Man_2, 5=Man_3, 6=Man_4, 7=Man_5, 8=Man_6)

Note1: Objects are used to change the mode ON or OFF. The mode takes the last action e.g. after overriding the ECO mode on via BO(1), the user can cancel the ECO mode from the screen. The present value field indicates the current state.

Note2: Multi-state Value is used to change the Blinds and Lights level. The levels action last change. E.g. if the level is changed via BACnet the user can consequently change the level again. The present value field indicates the current level.

Note3: It is possible to override the output level without changing the Y1/Y2/Y3 mode to network. The object returns to use the internal logic value once the priority inputs have been set to 'null'.

Note4: Priority Input 16 is reserved for system purposes on AV, BO and MSV objects.

App_Config Objects

NOTE: Application Configuration Objects expose the configuration parameters over the BACnet. However please check if your BACnet client can support Proprietary Object types to be able to access these parameters. Alternatively set the configuration parameters through the TRC touchscreen.

	Property Name /ID	Attributes	Range	Default
Required Object Properties	Object Identifier	R		proprietary-128
	Object Name	R/W		"Config1"
	Object Type	R		proprietary-128
Optional Properties	None			

	Property ID	Description	BACnet Data Type	Range
Proprietary Properties	40106	Setpoint Adjust Minimum	REAL	-20.0..0.0 °C/°F (Default -3.0)
	40107	Setpoint Adjust Maximum	REAL	0.0..20.0 °C/°F (Default 3.0)
	40110	Number of Heating Stages	Unsigned	0 = None 1 = 1-Stage (Default) 2 = 2-Stages
	40111	Heating Stage 1 Direction	Unsigned	0 = Reverse (Default), 1 = Direct
	40112	Heating Stage 2 Direction	Unsigned	0 = Reverse (Default), 1 = Direct
	40113	Number of Cooling Stages	Unsigned	0 = None 1 = 1-Stage (Default) 2 = 2-Stages
	40114	Cooling Stage 1 Direction	Unsigned	0 = Reverse, 1 = Direct (Default)
	40115	Cooling Stage 2 Direction	Unsigned	0 = Reverse, 1 = Direct (Default)
	40116	High Limit Setpoint	REAL	0..95°C/°F (Default 35.0°C)
	40117	Low Limit Setpoint	REAL	0..95°C/°F (Default 16.0°C)
	40118	Limit Ratio	REAL	0.0..5.0 (0.0=Disabled, Default)
	40120	CO2 Proportional Band	Unsigned	10..5000 ppm (Default = 300 ppm)
	40121	CO2 Control Integral Action	Unsigned	0..10,000 seconds (Default 0)
	40122	CO2 Output Direction	Unsigned	0 = Reverse Acting 1 = Direct Acting (Default)
	40124	Humidity Proportional Band	REAL	1.0...100.0 %rH (Default 20.0%)
	40125	Humidity Control Integral Action	Unsigned	0..10,000 seconds (Default 0)
	40126	Humidification Output Direction	Unsigned	0 = Reverse Acting 1 = Direct Acting (Default)
	40127	De-Humidification Output Direction	Unsigned	0 = Reverse Acting 1 = Direct Acting (Default)
	40128	Fan Speed Display	Unsigned	0 = No Display (Default) 1 = Display Only (no user adj.) 2 = 0 - 1 (0%, 100%) 3 = 0 - 1 - 2 (0%, 50%, 100%) 4 = 0 - 1 - 2 - 3 (0%, 33%, 66%, 100%) 5 = 0 - 1 - 2 - 3 - 4 - 5 - 6

	40129	Fan Speed Source	Unsigned	0 = Heating 1 and Cooling 1 Stage (Default) 1 = Heating Stage1 2 = Cooling Stage 1 3 = Heating and Cooling Stage 2 4 = Heating Stage 2 5 = Cooling Stage 2 6 = CO2 7 = Humidification 8 = De-Humidification 9 = Maximum VAV (Cooling/CO2) 10 = Maximum Temp/Hum 11 = Aux. Loop
	40130	Min Fan Level	Unsigned	0..100% (Default 0%)
	40131	Y1 Output Mode Default: Modulating Fan	Unsigned	0 = Network Value 1 = Heating Stage 1 2 = Heating Stage 2
	40132	Y2 Output Mode Default: Heating Stage 1 Default TRC-1A4R: Heating1 Stat	Unsigned	3 = Cooling Stage 1 4 = Cooling Stage 2 5 = Modulating Fan (EC)
	40133	Y3 Output Mode Default: Cooling Stage 1	Unsigned	6 = CO2 Control 7 = Maximum VAV 8 = Maximum Fan 9 = Humidification 10 = De-humidification 11 = Light Control 12 = Blinds Control 13 = Amber / Red 14 = Red 15 = Heating1 Sta 16 = Cooling1 Stat 17 = Fan Stat 18 = Aux. Loop 19 = 6-Port (Valve) 20 = 6-Port Reverse (Reverse Control)
	40143	Anti-JAM Time-out	Unsigned	0..14 Days 0 = Disabled (Default)
	40144	RI1 Mode	Unsigned	0 = Disabled (default)
	40145	RI2 Mode	Unsigned	1 = Room (NTC10 Control) 2 = Floor (NTC10 High/Low Lim) 3 = Aux. Loop 4 = Heating / Cooling (NTC10 Change-over) 5 = Network NTC10 6 = Network 0-10V 7 = CO2 0-10V (0..2000 =0-10V) 8 = Main Loop (0..50°C=0-10V) 9 = Close for ECO (DI-mode) 10 = Open for ECO (DI-mode) 11 = Close for OFF (DI-mode) 12 = Open for OFF (DI-mode) 13 = Condensation 14 = Network DI
	40146	Outside Temperature Source	Unsigned	0 = Built-In Sensor (Default) 1 = Network Sensor
	40148	Digital Input Mode	Unsigned	0 = Close for ECO (Default) 1 = Open for ECO 2 = Close for OFF 3 = Open for OFF 4 = Heating/Cooling Change-Over 5 = Disable Cooling 6 = Contact Alarm 7 = Network Measurement 8 = Close for BOOST (CE only) 9 = Open for BOOST (CE only)
	40149	Digital Input Delay	Unsigned	0..28,800 seconds (Default 0s)
	40150	Internal Sensor Calibration	REAL	-10.0..+10.0 °C/°F
	40151	RI1 Calibration	REAL	-10.0..+10.0 °C/°F
	40152	RI2 Calibration	REAL	-10.0..+10.0 °C/°F
	40153	CO2 Calibration	REAL	-500...+500 ppm
	40154	Humidity Calibration	REAL	-10.0..+10.0 % rH

	Property Name /ID	Attributes	Range	Default
Required Object Properties	Object Identifier	R		proprietary-128
	Object Name	R/W		"Config2"
	Object Type	R		proprietary-128
Optional Properties	None			

	Property ID	Description	BACnet Data Type	Range
Proprietary Properties	40155	Lock Mode	Unsigned	0 = Lock mode disabled (default) 1 = On/Off workable only 2 = Temp settings only available 3 = All buttons disabled
	40156	Lock Mode Password	REAL	0000...9999
	40157	Boost Time	Unsigned	0 = Permanent (Default 0) 1..480 minutes
	40158	Boost Target	Unsigned	0 = Boost Disabled 1 = Heating Stage 1 (default) 2 = Heating Stages 1&2 3 = Cooling Stage 1 4 = Cooling Stages 1&2 5 = Humidity Control Loop 6 = De-Humidity Loop 7 = CO2 Loop 8 = Fan
	40159	Lights Delay Time	Unsigned	0..1,800 Seconds (Default 30)
	40160	Lights Mode	Unsigned	0 = Disabled (default) 1 = 0-1 2 = 0-1-2 3 = 0-1-2-3
	40161	Lights Interlock	Unsigned	0 = Disabled (default) 1 = COMFORT 2 = COMFORT + ECO
	40162	Blinds Mode	Unsigned	0 = Disabled (default) 1 = Enabled, ON/OFF 2 = Enabled, 4-Steps
	40164	Display Humidity	Unsigned	0 = Disabled 1 = Enabled (default)
	40165	Show Swap Temperature Units Icon	Unsigned	0 = Disabled (default) 1 = Enabled

40166	Zone 1 Room Sensor Text Default: 1 = Room	Unsigned	0 = Disabled 1 = Room 2 = Floor 3 = Outside 4 = Zone 1 5 = Zone 2 6 = Zone 3 7 = Bathroom 8 = Sauna 9 = Bedroom 10 = Kitchen 11 = Cooler 12 = Flow 13 = Hot Water 14 = Tank 15 = Pool 16 = Cabin
40167	Zone 2 Floor Sensor Text Default: 2 = Floor	Unsigned	
40168	Zone 3 Outside Sensor Text Default: 3 = Outside	Unsigned	
40169	Alarm 1 Source	Unsigned	0 = CO2 1 = Room (Temperature) 2 = Humidity 3 = None (Default)
40170	Alarm 1 Amber Switching Point	Unsigned	0..5000 (Default 0)
40171	Alarm 1 Red Switching Point	Unsigned	0..5000 (Default 0)
40172	Alarm 1 Hysteresis	Unsigned	0..5000 (Default 0)
40173	Alarm 2 Source	Unsigned	0 = CO2 1 = Room (Temperature) 2 = Humidity 3 = None (Default)
40174	Alarm 2 Amber Switching Point	Unsigned	0..5000 (Default 0)
40175	Alarm 2 Red Switching Point	Unsigned	0..5000 (Default 0)
40176	Alarm 2 Hysteresis	Unsigned	0..5000 (Default 0)
40180	Maintenance Mode Password	Unsigned	0000...9999 (default 6666)
40181	Staff Code	Unsigned	0000...9999 (default 0000)
40182	PWM1 Cycle for DO1 (Only TRC-1A2T/3R2T)	Unsigned	0..120 None (default 30, 0=on/off)
40185	Heating/Cooling Changeover Min Temperature	REAL	0.0...95.0°C/°F (Default 20°C)
40186	Heating/Cooling Changeover Max Temperature	REAL	0.0...95.0°C/°F (Default 25°C)
40188	Fan Off Delay - Only applicable if Min Fan Level is set.	Unsigned	0..28,800 seconds (Default 0) 0 = Infinite Delay
40190	Aux Heating Loop Proportional Band	Unsigned	1.0...50.0°C/°F (Default 4°C)
40191	Aux Heating Loop Control Integral Action	Unsigned	0..1,200 seconds (Default 600)
40192	Aux Loop Actuator Direction (actuator direction, Direct = 0..100%, Reverse = 100..0%)	Unsigned	0 = Reverse Acting 1 = Direct Acting (Default)
40193	PWM2 Cycle (Only TRC-1A2T/3R2T from Fw4.15)	Unsigned	0..120 None (default 30, 0=on/off)
40194	Thermic 1 Mode Default: Heating Stage 1 (From Fw 4.15 onwards)	Unsigned	0 = Network Value 1 = Heating Stage 1 2 = Heating Stage 2 3 = Cooling Stage 1 4 = Cooling Stage 2 5 = CO2 Control 6 = Humidification 7 = De-humidification 8 = Aux Control Demand
40195	Thermic 2 Mode Default: Cooling Stage 1 (From Fw 4.15 onwards)	Unsigned	
40200	Address	Unsigned	0..127 (Default 1)
40201	Baud Rate	Unsigned	0 = 9600 (Default) 1 = 19200 2 = 38400 3 = 57600 4 = 76800

40202	Parity	Unsigned	0 = None (Default) 1 = Odd 2 = Even
40203	Stop Bits	Unsigned	0 = 1 Stop Bit (Default) 1 = 2 Stop Bits
40300	Force Reset	Unsigned	0 = Normal 1 = Force Reset
40301	Non Volatile Memory Update	Unsigned	0 = Normal 1 = Update
40303	Force Factory Defaults	Unsigned	0 = Normal 1 = Force Defaults
40304	Screen Refresh Rate	Unsigned	0 = Fast (Default) 1 = Medium 2 = Slow
40306	Language	Unsigned	0 = English (Default) 1 = Finnish 2 = Swedish 3 = French 4 = Polish 5 = Italian 6 = Spanish 7 = Catalan 8 = Euskera
40308	Show Language Swap Icon	Unsigned	0 = Disabled (Default) 1 = Enabled

NOTE: Information is subject to change without prior notice.

Dimensions

