

OptixPanel™ Standard

FactoryTalk® Optix™-based operator panels
for visualization and maximum connectivity



HIGHLIGHTS

- Embedded solutions based on FactoryTalk® Optix™, the new collaborative, cloud-based software platform that offers an unprecedented degree of flexibility, scalability, extensibility and openness for visualization and Edge Computing applications
- Full industrial interoperability for M2M scenarios and interfacing to MES and ERP systems thanks to native support for the OPC UA protocol, simple two-way communication with Cloud infrastructures via MQTT protocol
- Aluminum and aluminum True Flat bezel designs with resistive touchscreen
- Glass frontal bezel design with multitouch back-projected capacitive touchscreen
- Stainless steel bezel design with resistive touchscreen
- Available with 8.4", 10.4", 12.1" and 15" in 4:3 aspect ratio and 7", 10.1", 12.1", 15.6", 18.5" and 21.5" in Wide aspect ratio
- Natively equipped with two Gigabit Ethernet ports, two USB 3.0 ports and a multistandard serial
- Integrated FactoryTalk® Remote Access™ software for remote assistance (UBIQUITY license compatible)

FT Optix™ INSIDE

FT Remote Access™ INSIDE

IP69K



OPC UA

MQTT

OptixPanel™ Standard

DIMENSIONS

FRONT VIEW

CUT-OUT

SIDE VIEW

OptixPanel™ Standard - AF/GL (Wide)

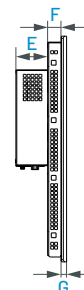
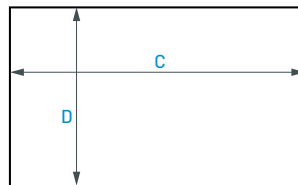
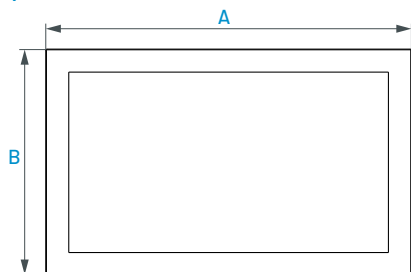

LCD	A	B	C	D	E	F (ALU/TFM)	G (ALU/TFM)
7"W	207	150.5	196	140	54	-	5/6
10,1"W	269.5	188	255.5	174	43	16.8/17.3	5/6.5
12,1"W	315	217	301	203	43	19.8/20.3	5/7.5
15,6"W	401.5	251	388	238	43	21.8/22.3	5/7.5
18,5"W	467	288	453	274	43	19.8/20.3	7/10.5
21,5"W	534	325.5	520	312	43	19.8/20.3	7/10.5

OptixPanel™ Standard - AF/AT (4:3)

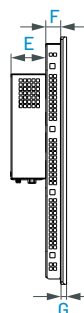
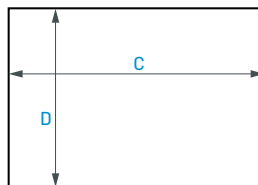
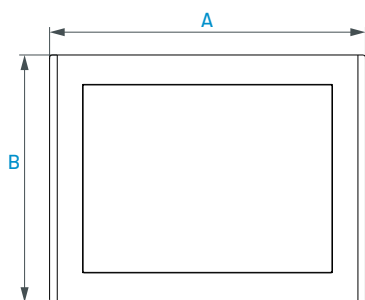

LCD	A	B	C	D	E	F	G
10,4"	296	231	283	219	43	18.8	6
12,1"	326	261	315	250	43	18.8	6
15"	391	306	380	295	43	18.8	7

DIMENSIONS

FRONT VIEW

CUT-OUT

SIDE VIEW

OptixPanel™ Standard - SS

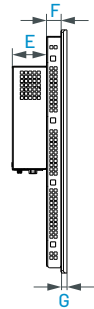
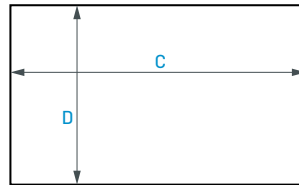
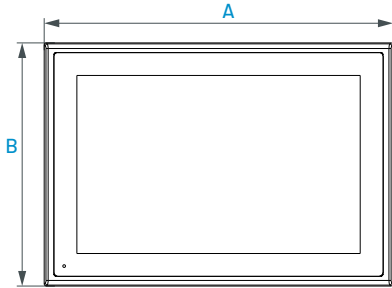

LCD	A	B	C	D	E	F (ALU/TFM)	G (ALU/TFM)
10,1"W	278.5	196.5	255.5	174	43	17.6	5.3
12,1"W	324	226	301	203	43	20.6	5.3
15,6"W	410.5	260	388	238	43	23.6	5.3
18,5"W	476	297	453	274	43	21.6	5.3
21,5"W	543.5	334.5	520	312	43	21.6	5.3

I/O SHIELD

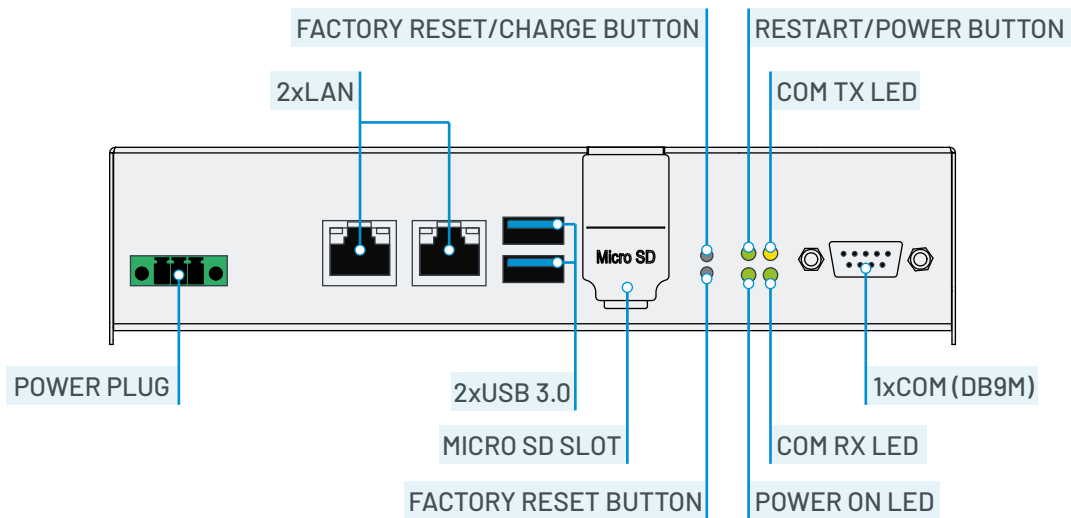

TECHNICAL DATA

OptixPanel™ Standard

HMI SOFTWARE	FactoryTalk® Optix™ runtime (Upgradable to L)			
REMOTE ASSISTANCE SW	FactoryTalk® Remote Access™ PRO (UBIQUITY compatible)			
O.S. INSTALLED	Linux Yocto			
LED BACKLIGHT TFT LCD	7" W - 800x480 10,1" W - 1280x800 12,1" W - 1280x800 15,6" W - 1920x1080 18,5" W - 1920x1080 21,5" W - 1920x1080	10.4" 4:3 - 800x600 12.1" 4:3 - 1024x768 15" 4:3 - 1024x768	7" W - 800x480 10,1" W - 1280x800 12,1" W - 1280x800 15,6" W - 1920x1080 18,5" W - 1920x1080 21,5" W - 1920x1080	10,1" W - 1280x800 12,1" W - 1280x800 15,6" W - 1920x1080 18,5" W - 1920x1080 21,5" W - 1920x1080
CUT-OUT	QT	A/B	QT	QT
TOUCHSCREEN	Resistive 5 wires		P-CAP Multitouch	Resistive 5 wires
BEZEL DESIGN	Aluminum frame (AF)	Aluminum TrueFlat (AT)	Glass (GL)	Stainless Steel (SS)
Logo	AB or brandless			
PROTECTION GRADE IP	IP rating	IP65 - frontal		IP69K - frontal
	NEMA rating	UL type 1, 4x (indoor only), pending		
CASE	Installation	Panel mounting		
	Material	Zinc-coated skin pass steel		
PROCESSOR (soldered on-board)	NXP® i.MX 8M Plus Quad ARM® Cortex® A53 1.6GHz • 64bit • integrated GPU			
SYSTEM MEMORY RAM	4GB (LP-DDR4 module)			
MASS STORAGE	~12GB eMMC TLC			
STORAGE EXPANSION	1x MicroSD slot on board with external access (push-push)			
INTERFACES	LAN	2x Gigabit Ethernet (RJ45)		
	USB	2x USB 3.0 (Type-A / host)		
	SERIAL	1x RS232/422/485 (DB9M) isolated		
POWER SUPPLY INPUT	24VDC (9 ÷ 32VDC) isolated			
BATTERY	1x BR2032A Internal access			
OPERATING TEMPERATURE	0° ÷ 50°C			
STORAGE TEMPERATURE	-20° ÷ 60°C			
OPERATING/STORAGE RELATIVE HUMIDITY	20% ÷ 90% RH (non-condensing)			
APPROVALS	CE, cULus Listed, UKCA, ATEX, KC, RCM, MOROCCO, ODVA			